



**HİLAL**  
Alüminyum

**PROFİL KATALOĐU**















## **SERAMİK PROFİLLERİ**

*CERAMIC PROFILES*















★ Profil Ağırlıkları Teorik Olup Teslim Anındaki Ağırlık Geçerlidir

★ *Weight of profiles are theoretical, net weight will valid at the time of delivery.*





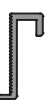









★ Yandaki profil birim ağırlıkları, bilgisayarda hesaplanmış teorik ağırlıklardır.

PROFİL KESİTİ	PROFİL KODU	PROFİL ADI	AĞIRLIK	ATALET MOMENTLERİ		SAYFA NO
				$J_x$ (cm <sup>4</sup> )	$J_y$ (cm <sup>4</sup> )	
	1755	...	0,290 kg/m	...	...	
	1756	...	0,319 kg/m	...	...	
	1121	...	0,486 kg/m	...	...	
	1222	...	0,490 kg/m	...	...	
	1831	...	1,199 kg/m	...	...	
	1832	...	0,235 kg/m	...	...	
	1833	...	0,293 kg/m	...	...	
	1834	...	0,288 kg/m	...	...	
	2842	...	0,947 kg/m	...	...	
	1255	...	0,603 kg/m	...	...	
	1477	...	0,956 kg/m	...	...	
	1394	...	0,479 kg/m	...	...	
	1801	...	0,801 kg/m	...	...	
	1840	...	0,308 kg/m	...	...	













★ Yandaki profil birim ağırlıkları, bilgisayarda hesaplanmış teorik ağırlıklardır.

PROFİL KESİTİ	PROFİL KODU	PROFİL ADI	AĞIRLIK	ATALET MOMENTLERİ		SAYFA NO
				$J_x$ (cm <sup>4</sup> )	$J_y$ (cm <sup>4</sup> )	
	1033	...	0,421 kg/m	...	...	
	1592	...	0,569 kg/m	...	...	
	1747	...	0,558 kg/m	...	...	
	1170	...	0,578 kg/m	...	...	
	1158	...	0,560 kg/m	...	...	
	1797	...	0,742 kg/m	...	...	
	1192	...	1,093 kg/m	...	...	
	1193	...	0,280 kg/m	...	...	
	1884	...	0,448 kg/m	...	...	
	1882	...	0,278 kg/m	...	...	
	1883	...	0,318 kg/m	...	...	
	1543	...	0,427 kg/m	...	...	
	1544	...	0,297 kg/m	...	...	
	1358	...	0,226 kg/m	...	...	

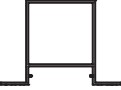

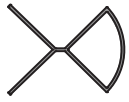
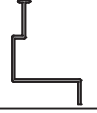

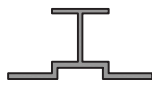





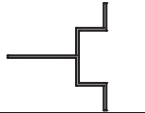



★ Yandaki profil birim ağırlıkları, bilgisayarda hesaplanmış teorik ağırlıklardır.

PROFİL KESİTİ	PROFİL KODU	PROFİL ADI	AĞIRLIK	ATALET MOMENTLERİ		SAYFA NO
				$J_x$ (cm <sup>4</sup> )	$J_y$ (cm <sup>4</sup> )	
	1733	...	0,477 kg/m	...	...	
	1734	...	0,553 kg/m	...	...	
	1753	...	0,700 kg/m	...	...	
	1476	...	0,220 kg/m	...	...	
	1261	...	1,329 kg/m	...	...	
	1335	...	0,433 kg/m	...	...	
	1464	...	0,435 kg/m	...	...	
	1649	...	0,278 kg/m	...	...	
	1364	...	0,333 kg/m	...	...	
	1366	...	0,133 kg/m	...	...	
	1754	...	0,718 kg/m	...	...	
	1566	...	0,696 kg/m	...	...	
	1565	...	1,051 kg/m	...	...	
	1316	...	0,563 kg/m	...	...	

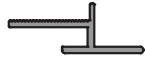

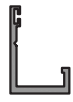



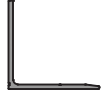

★ Yandaki profil birim ağırlıkları, bilgisayarda hesaplanmış teorik ağırlıklardır.

PROFİL KESİTİ	PROFİL KODU	PROFİL ADI	AĞIRLIK	ATALET MOMENTLERİ		SAYFA NO
				$J_x$ (cm <sup>4</sup> )	$J_y$ (cm <sup>4</sup> )	
	1748	...	0,394 kg/m	...	...	
	1368	...	0,394 kg/m	...	...	
	1692	...	0,540 kg/m	...	...	
	1682	...	0,139 kg/m	...	...	
	1355	...	0,541 kg/m	...	...	
	1354	...	0,751 kg/m	...	...	
	2098	...	1,095 kg/m	...	...	
	1632	...	1,407 kg/m	...	...	
	1482	...	1,449 kg/m	...	...	
	1798	...	1,215 kg/m	...	...	
	1978	...	0,517 kg/m	...	...	
	3776	...	0,494 kg/m	...	...	
	3777	...	0,269 kg/m	...	...	
	3778	...	0,378 kg/m	...	...	

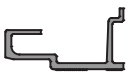
★ Yandaki profil birim ağırlıkları, bilgisayarda hesaplanmış teorik ağırlıklardır.

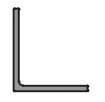
PROFİL KESİTİ	PROFİL KODU	PROFİL ADI	AĞIRLIK	ATALET MOMENTLERİ		SAYFA NO
				$J_x$ (cm <sup>4</sup> )	$J_y$ (cm <sup>4</sup> )	
	3192	...	0,910 kg/m	...	...	
	3220	...	0,484 kg/m	...	...	
	3221	...	0,268 kg/m	...	...	
	3222	...	0,220 kg/m	...	...	
	3668	...	0,563 kg/m	...	...	
	3748	...	0,748 kg/m	...	...	
	3802	...	1,257 kg/m	...	...	
	3954	...	0,334 kg/m	...	...	
	3955	...	0,436 kg/m	...	...	
	3999	...	0,708 kg/m	...	...	
	4015	...	0,461 kg/m	...	...	
	4016	...	0,488 kg/m	...	...	
	4798	...	0,131 kg/m	...	...	
	4068	...	0,640 kg/m	...	...	

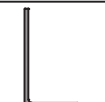
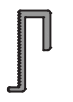
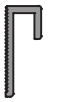
★ Yandaki profil birim ağırlıkları, bilgisayarda hesaplanmış teorik ağırlıklardır.

PROFİL KESİTİ	PROFİL KODU	PROFİL ADI	AĞIRLIK	ATALET MOMENTLERİ		SAYFA NO
				$J_x$ (cm <sup>4</sup> )	$J_y$ (cm <sup>4</sup> )	
	2637	...	0,954 kg/m	...	...	
	2999	...	0,594 kg/m	...	...	
	2634	...	0,909 kg/m	...	...	
	2635	...	1,500 kg/m	...	...	
	2636	...	1,074 kg/m	...	...	
	1365	...	1,168 kg/m	...	...	
	1367	...	1,379 kg/m	...	...	
	1369	...	1,802 kg/m	...	...	
	1370	...	1,590 kg/m	...	...	
	2900	...	0,353 kg/m	...	...	
	2901	...	0,297 kg/m	...	...	
	3025	...	0,871 kg/m	...	...	
	3026	...	1,531 kg/m	...	...	
	3222	...	0,220 kg/m	...	...	





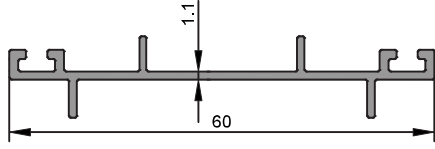

**1755**  
0,290 kg/m

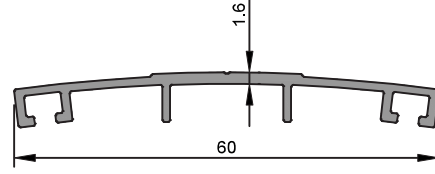

**1756**  
0,319 kg/m

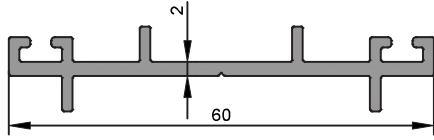

**1121**  
0,486 kg/m

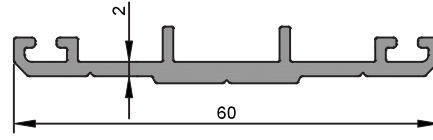

**1222**  
0,490 kg/m

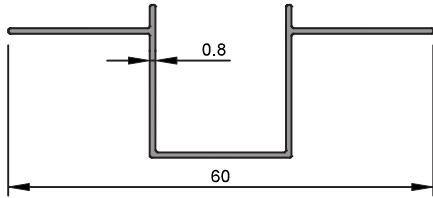

**1831**  
0,220 kg/m

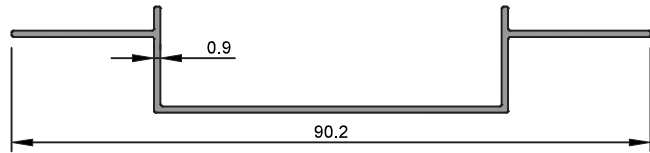

**1834**  
0,288 kg/m

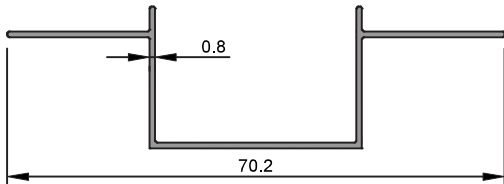

**1832**  
0,235 kg/m

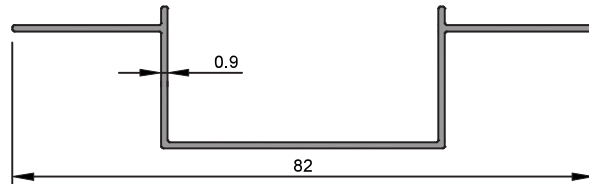

**1833**  
0,293 kg/m

★ Yandaki profil birim ağırlıkları, bilgisayarda hesaplanmış teorik ağırlıklardır.

★ Yandaki profil birim ağırlıkları, bilgisayarda hesaplanmış teorik ağırlıklardır.

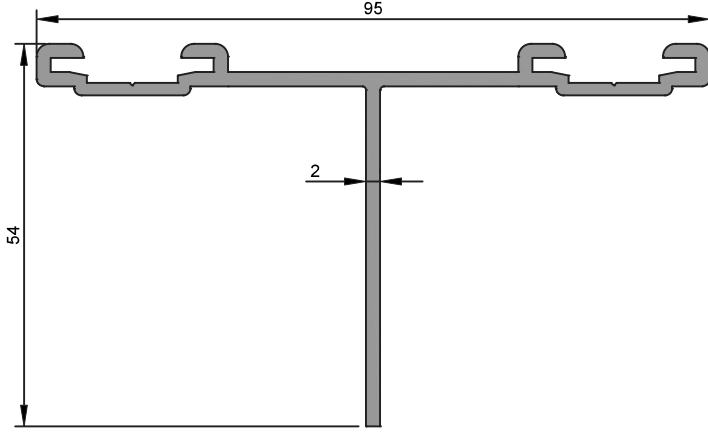

<b>1060</b>
0,947 kg/m

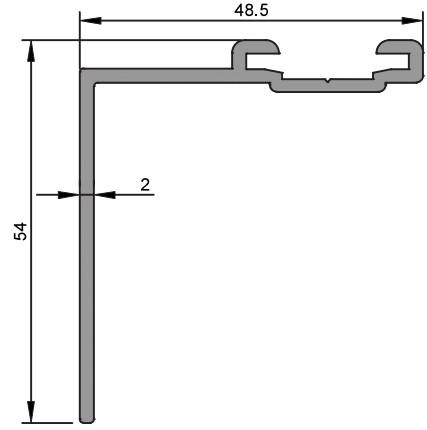

<b>1255</b>
0,603 kg/m

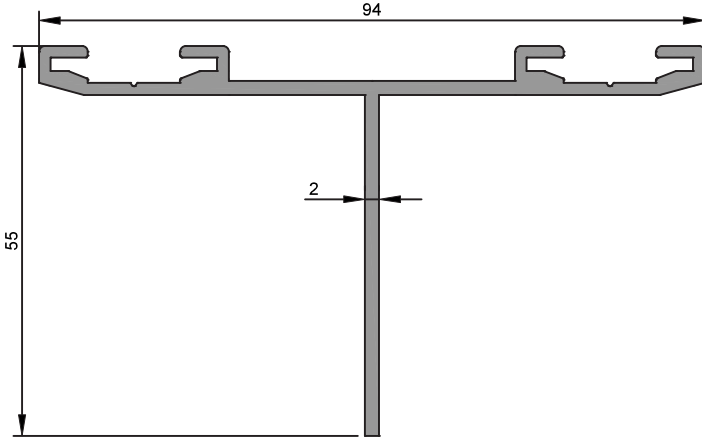

<b>1477</b>
0,956 kg/m

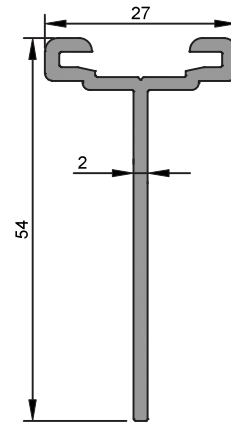

<b>1394</b>
0,479 kg/m

★ Yandaki profil birim ağırlıkları, bilgisayarda hesaplanmış teorik ağırlıklardır.

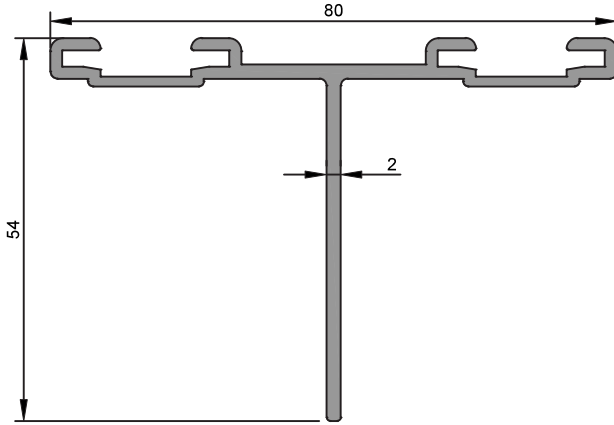

<b>1801</b>
0,805 kg/m

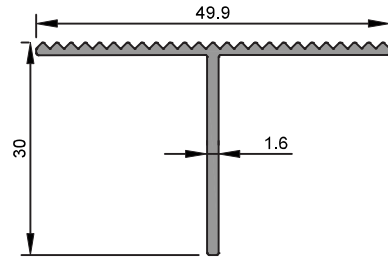

<b>1840</b>
0,308 kg/m

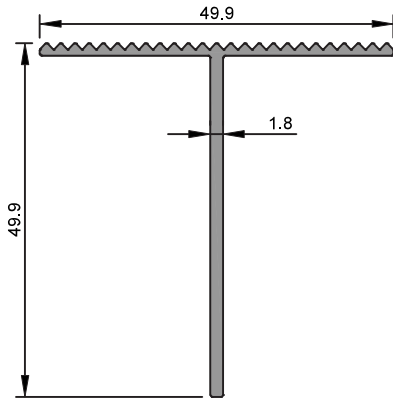

<b>1033</b>
0,421 kg/m

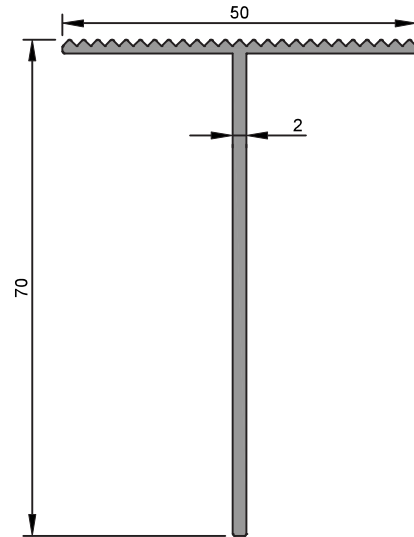

<b>1592</b>
0,569 kg/m

★ Yandaki profil birim ağırlıkları, bilgisayarda hesaplanmış teorik ağırlıklardır.

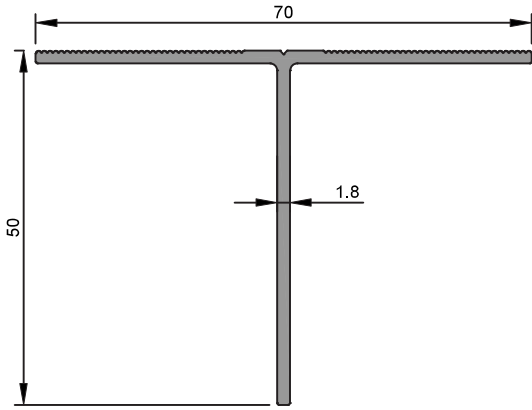

<b>1747</b>
0,558 kg/m

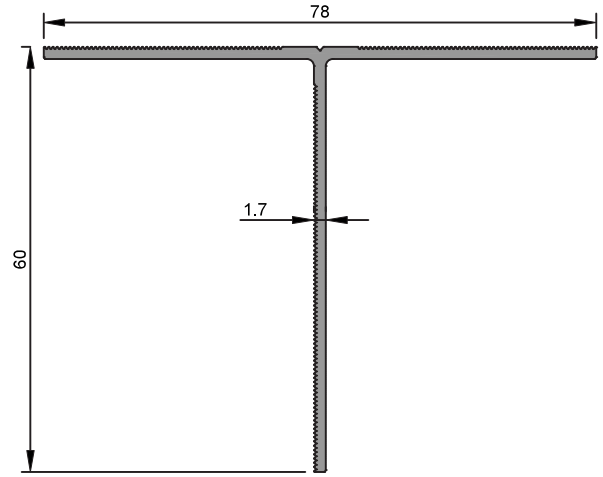

<b>1170</b>
0,578 kg/m

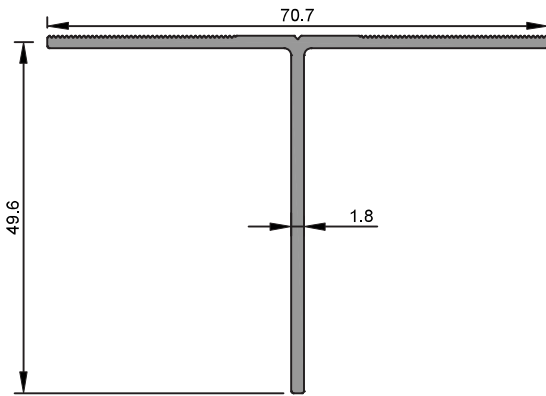

<b>1158</b>
0,560 kg/m

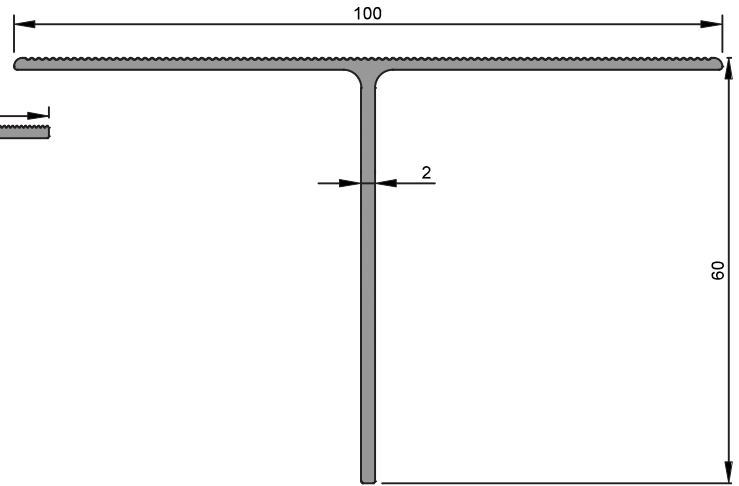

<b>1797</b>
0,742 kg/m

★ Yandaki profil birim ağırlıkları, bilgisayarda hesaplanmış teorik ağırlıklardır.

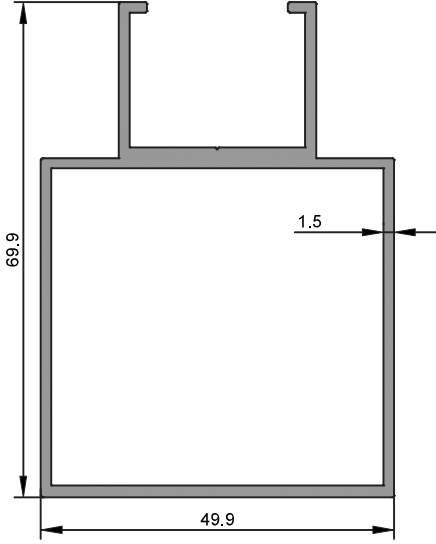

**1192**  
1,093 kg/m

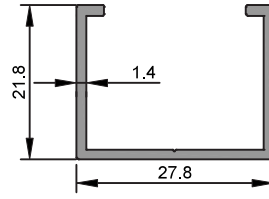

**1193**  
0,280 kg/m

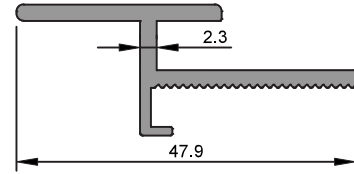

**1884**  
0,448 kg/m

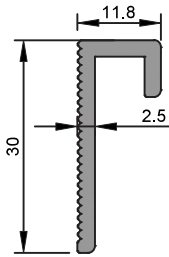

**1882**  
0,278 kg/m

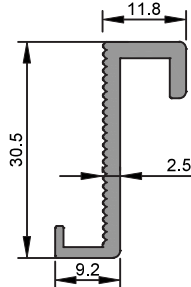

**1883**  
0,318 kg/m

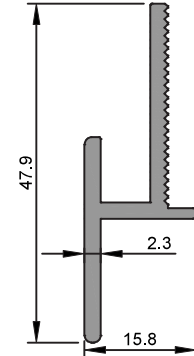

**1543**  
0,427 kg/m

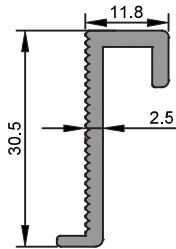

**1544**  
0,297 kg/m

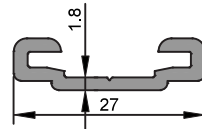

**1358**  
0,226 kg/m

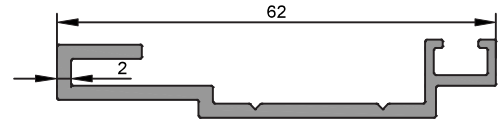

**1733**  
0,477 kg/m

★ Yandaki profil birim ağırlıkları, bilgisayarda hesaplanmış teorik ağırlıklardır.

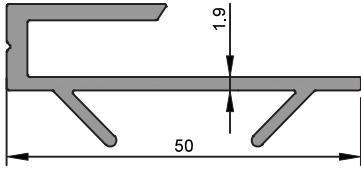

**1734**

0,553 kg/m

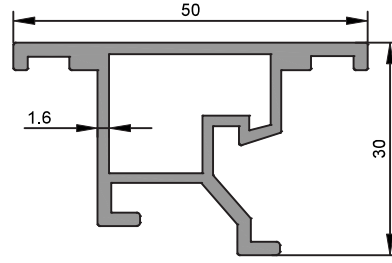

**1753**

0,700 kg/m

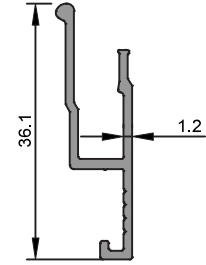

**1476**

0,220 kg/m

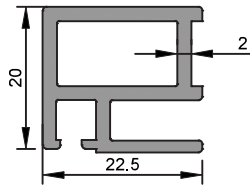

**1261**

1,329 kg/m

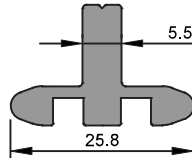

**1335**

0,433 kg/m

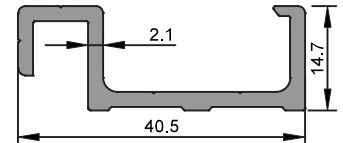

**1464**

0,435 kg/m

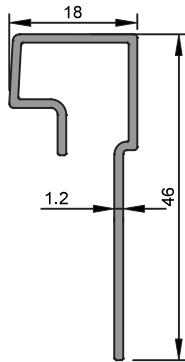

**1649**

0,278 kg/m

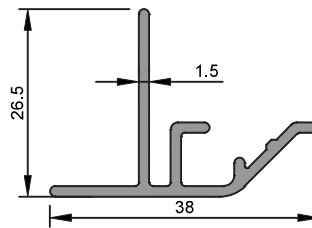

**1364**

0,333 kg/m

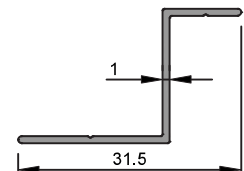

**1366**

0,133 kg/m

★ Yandaki profil birim ağırlıkları, bilgisayarda hesaplanmış teorik ağırlıklardır.

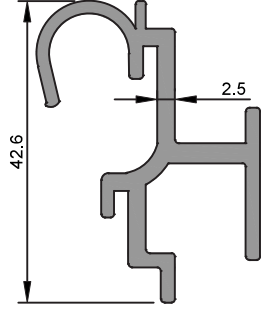

**1754**  
0,718 kg/m

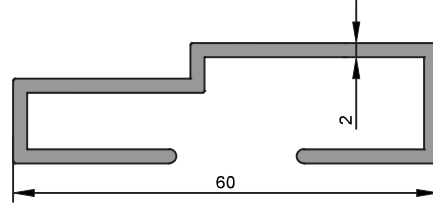

**1566**  
0,696 kg/m

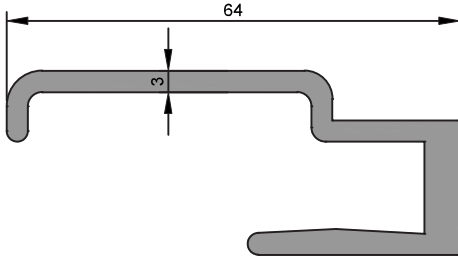

**1565**  
1,051 kg/m

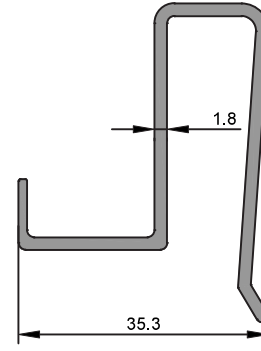

**1316**  
0,563 kg/m

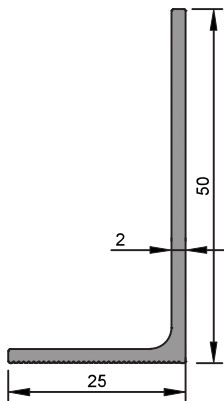

**1748**  
0,394 kg/m

★ Yandaki profil birim ağırlıkları, bilgisayarda hesaplanmış teorik ağırlıklardır.

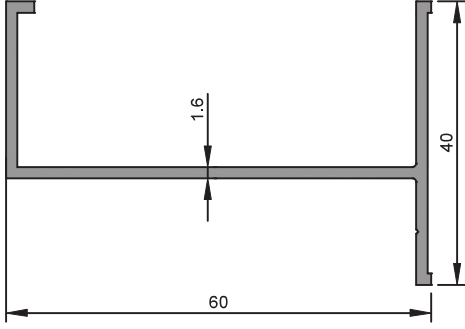

<b>1692</b>
0,540 kg/m

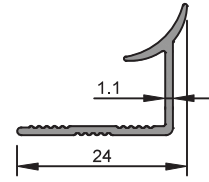

<b>1682</b>
0,139 kg/m

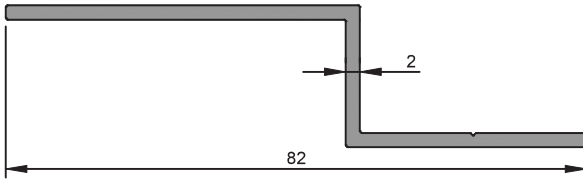

<b>1355</b>
0,541 kg/m

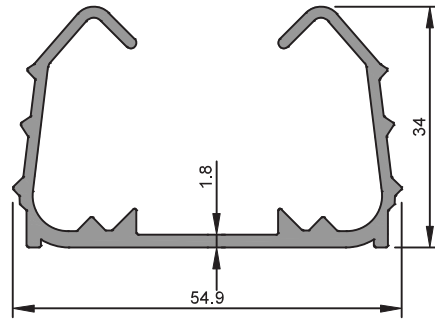

<b>1354</b>
0,751 kg/m



★ Yandaki profil birim ağırlıkları, bilgisayarda hesaplanmış teorik ağırlıklardır.

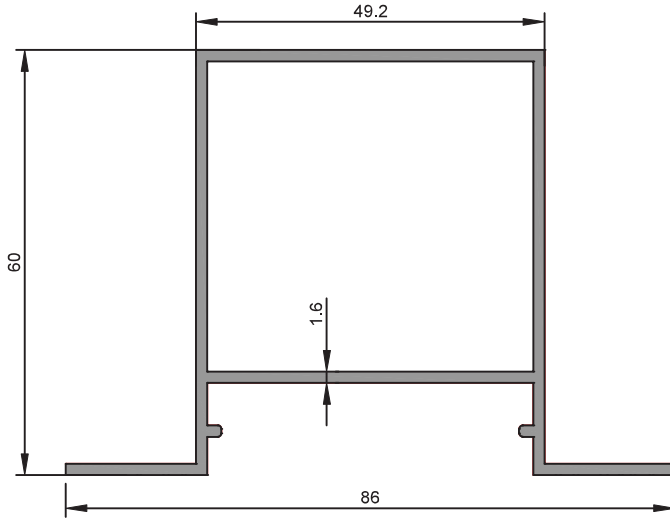

<b>2098</b>
1,095 kg/m

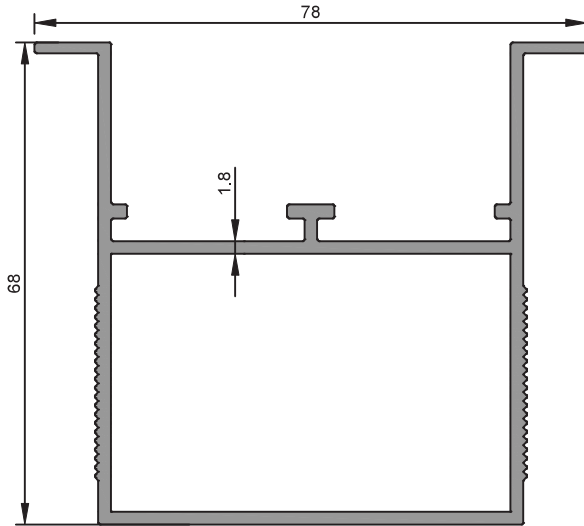

<b>1632</b>
1,407 kg/m

★ Yandaki profil birim ağırlıkları, bilgisayarda hesaplanmış teorik ağırlıklardır.

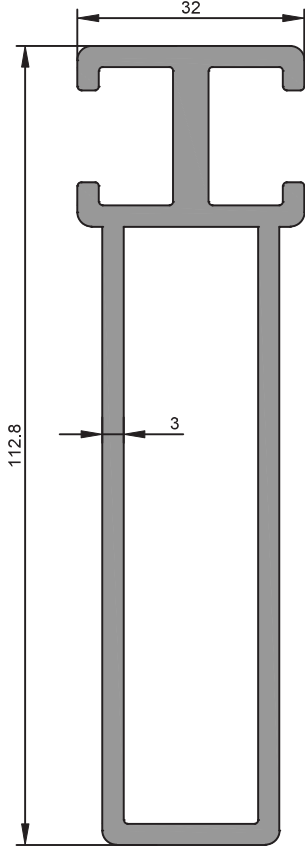

**1482**  
1,449 kg/m

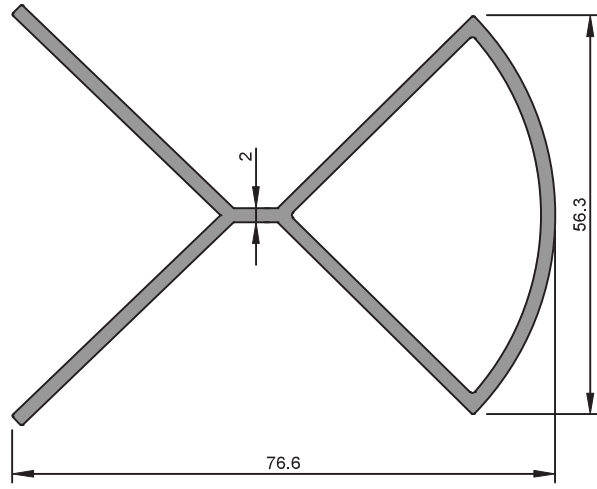

**1798**  
1,215 kg/m

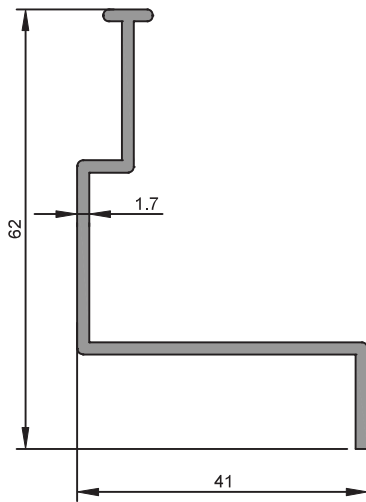

**1978**  
0,517 kg/m

★ Yandaki profil birim ağırlıkları, bilgisayarda hesaplanmış teorik ağırlıklardır.

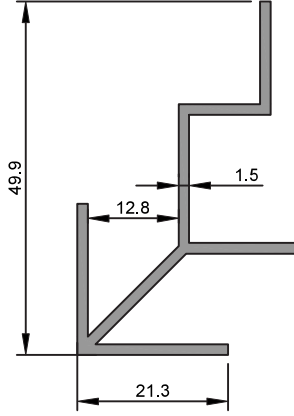

<b>3776</b>
0,494 kg/m

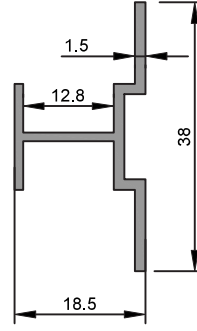

<b>3777</b>
0,269 kg/m

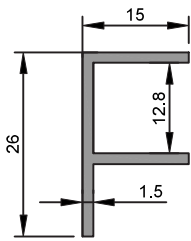

<b>3778</b>
0,217 kg/m

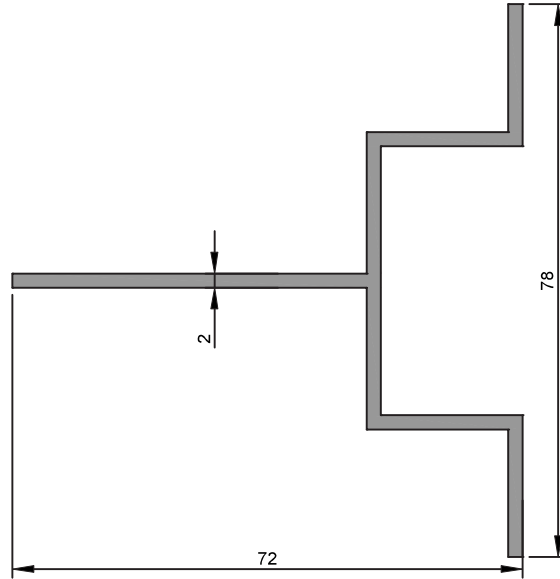

<b>3192</b>
0,910 kg/m

★ Yandaki profil birim ağırlıkları, bilgisayarda hesaplanmış teorik ağırlıklardır.

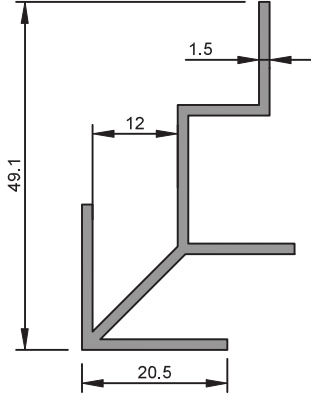

<b>3220</b>
0,484 kg/m

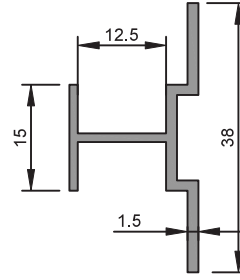

<b>3221</b>
0,268 kg/m

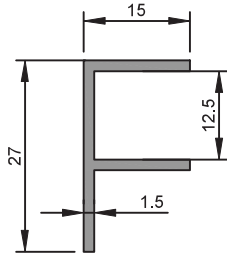

<b>3222</b>
0,220 kg/m

★ Yandaki profil birim ağırlıkları, bilgisayarda hesaplanmış teorik ağırlıklardır.

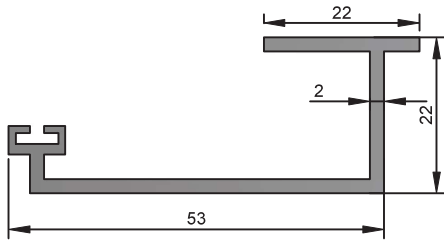

<b>3668</b>
0,563 kg/m

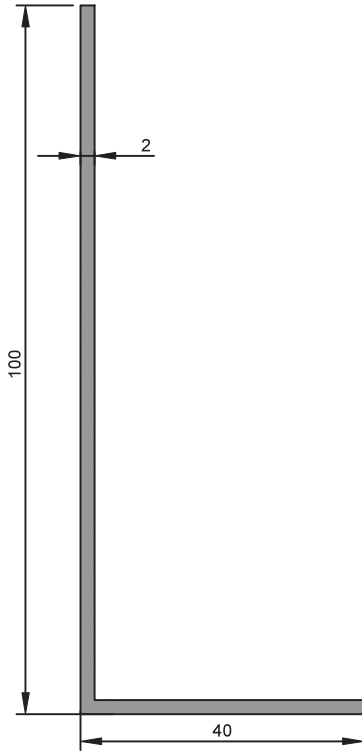

<b>3748</b>
0,748 kg/m

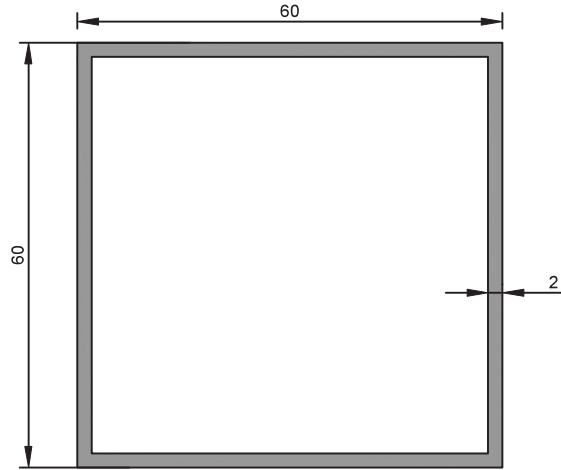

<b>3802</b>
1,257 kg/m

★ Yandaki profil birim ağırlıkları, bilgisayarda hesaplanmış teorik ağırlıklardır.

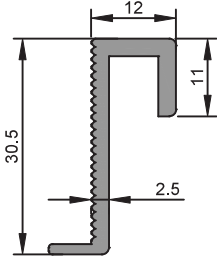

**3954**  
0,334 kg/m

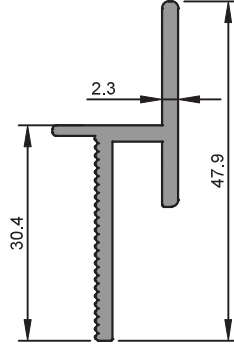

**3955**  
0,436 kg/m

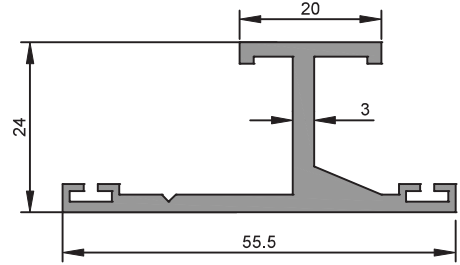

**3999**  
0,708 kg/m

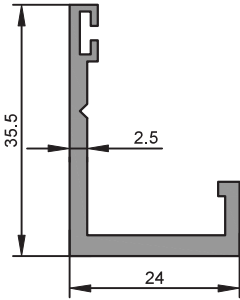

**4015**  
0,461 kg/m

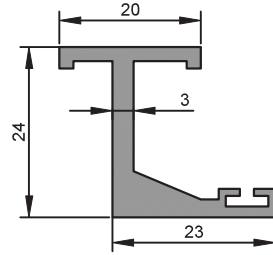

**4016**  
0,488 kg/m

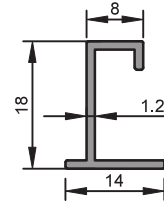

**4798**  
0,131 kg/m

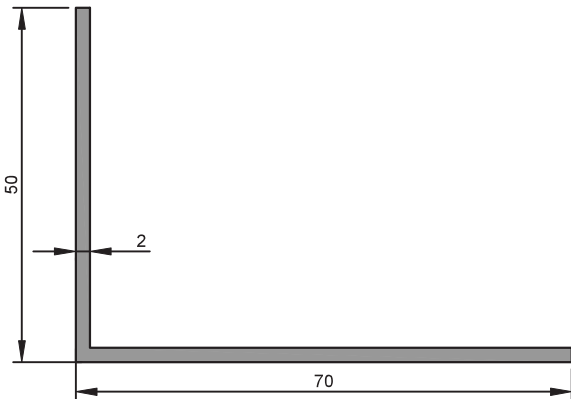

**4068**  
0,640 kg/m

★ Yandaki profil birim ağırlıkları, bilgisayarda hesaplanmış teorik ağırlıklardır.

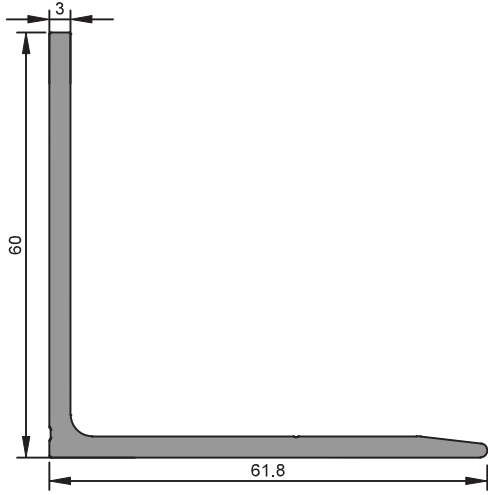

**2637**  
0,954 kg/m

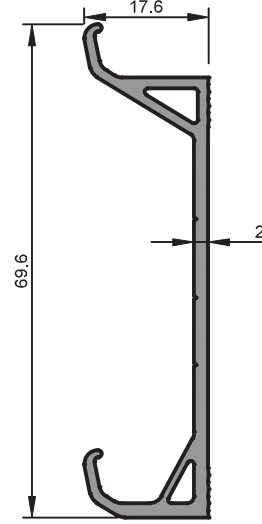

**2999**  
0,594 kg/m

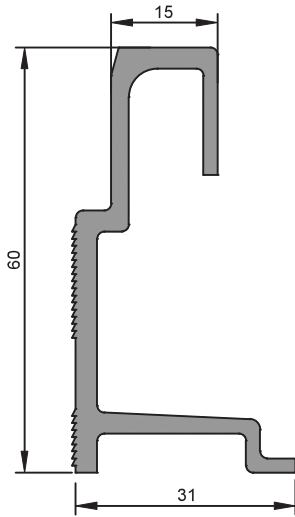

**2634**  
0,909 kg/m

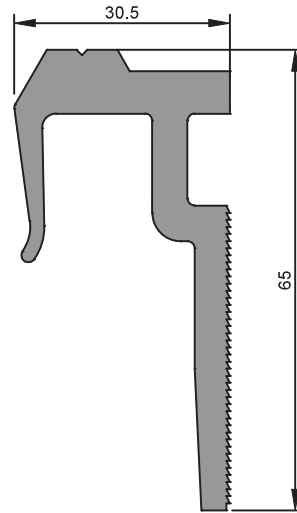

**2635**  
1,500 kg/m

★ Yandaki profil birim ağırlıkları, bilgisayarda hesaplanmış teorik ağırlıklardır.

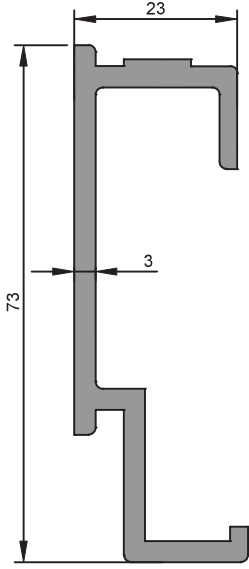

**2636**

1,074 kg/m

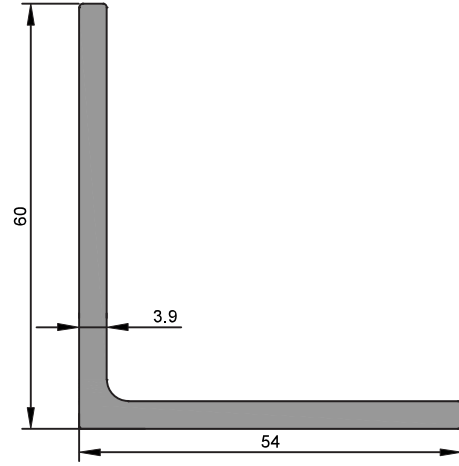

**1365**

1,168 kg/m

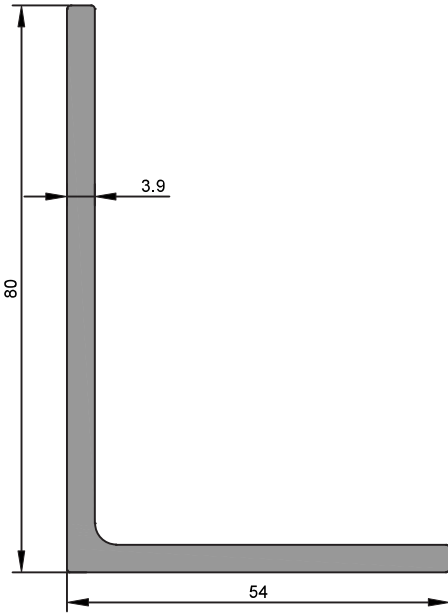

**1367**

1,379 kg/m



★ Yandaki profil birim ağırlıkları, bilgisayarda hesaplanmış teorik ağırlıklardır.

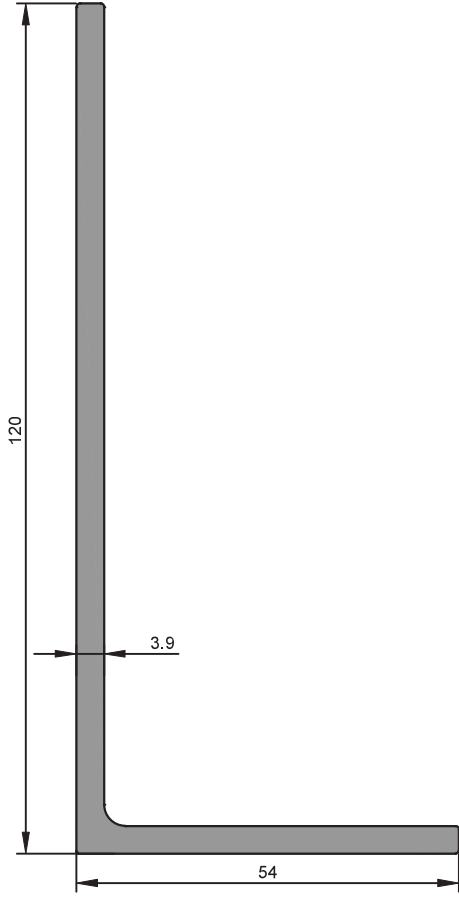

<b>1369</b>
1,802 kg/m

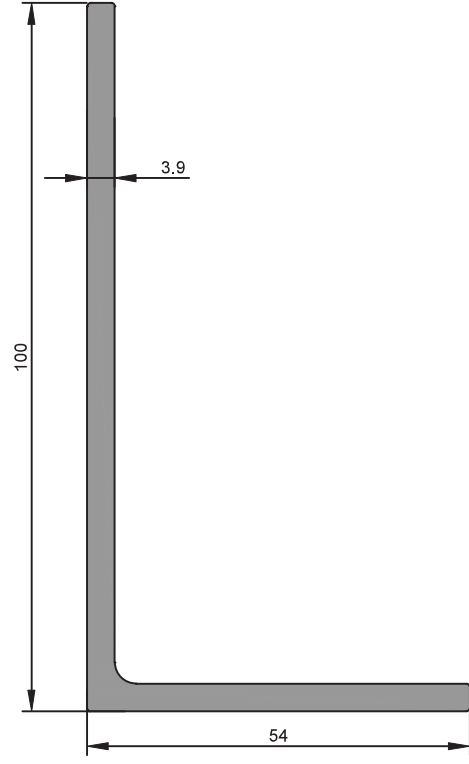

<b>1370</b>
1,590 kg/m

★ Yandaki profil birim ağırlıkları, bilgisayarda hesaplanmış teorik ağırlıklardır.

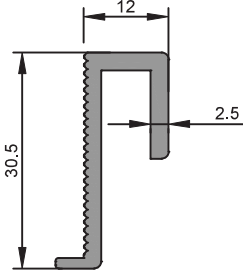

<b>2900</b>
0,353 kg/m

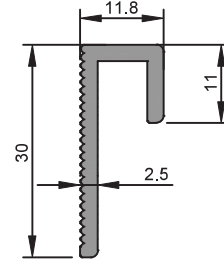

<b>2901</b>
0,297 kg/m

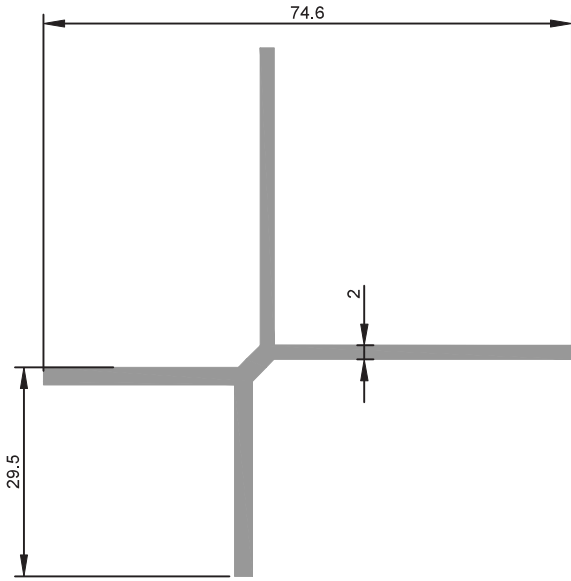

<b>3025</b>
0,871 kg/m

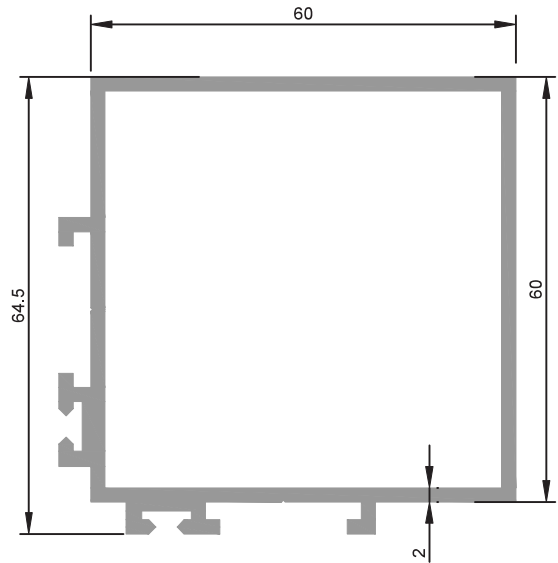

<b>3026</b>
1,531 kg/m

★ Yandaki profil birim ağırlıkları, bilgisayarda hesaplanmış teorik ağırlıklardır.

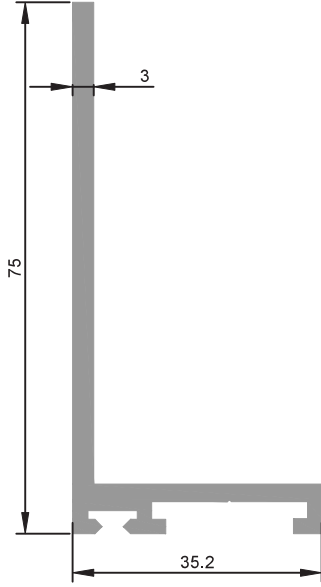

<b>3027</b>
0,928 kg/m

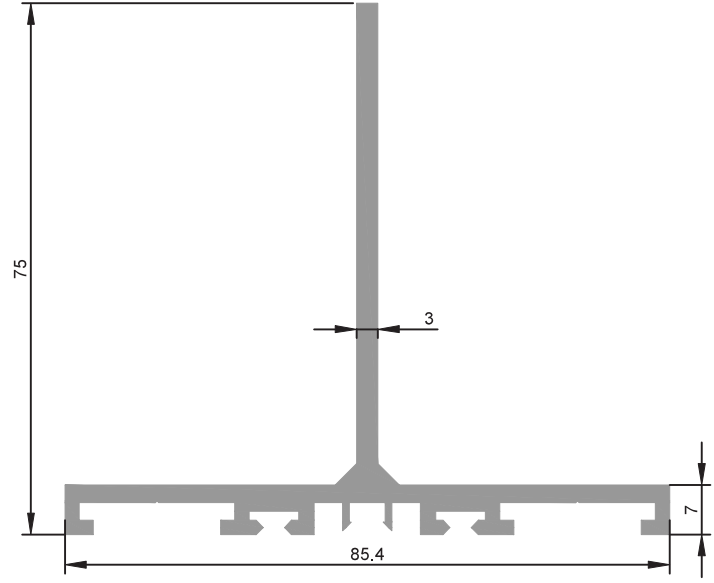

<b>3028</b>
1,448 kg/m

