



HİLAL
Alüminyum

PROFİL KATALOĐU















ZEMİN PROFİLLER

FLOORING PROFILE















* Profil Ağırlıkları Teorik Olup Teslim Anındaki Ağırlık Geçerlidir

* *Weight of profiles are theoretical, net weight will valid at the time of delivery.*















★ Yandaki profil birim ağırlıkları, bilgisayarda hesaplanmış teorik ağırlıklardır.

PROFİL KESİTİ	PROFİL KODU	PROFİL ADI	AĞIRLIK	ATALET MOMENTLERİ		SAYFA NO
				J_x (cm ⁴)	J_y (cm ⁴)	
	1822	...	0,158 kg/m	
	1253	...	0,116 kg/m	
	1752	...	0,126 kg/m	
	1254	...	0,64 kg/m	
	1572	...	1,92 kg/m	
	1774	...	0,96 kg/m	
	1746	...	0,99 kg/m	
	1031	...	0,133 kg/m	
	1795	...	0,87 kg/m	
	1475	...	0,183 kg/m	
	1295	...	0,151kg/m	
	2751	...	0,196 kg/m	
	1574	...	0,101 kg/m	
	1681	...	0,75 kg/m	















★ Yandaki profil birim ağırlıkları, bilgisayarda hesaplanmış teorik ağırlıklardır.

PROFİL KESİTİ	PROFİL KODU	PROFİL ADI	AĞIRLIK	ATALET MOMENTLERİ		SAYFA NO
				J_x (cm ⁴)	J_y (cm ⁴)	
	1773	...	0,97 kg/m	
	1781	...	0,110 kg/m	
	1780	...	0,144 kg/m	
	1775	...	0,141 kg/m	
	1575	...	0,105 kg/m	
	1571	...	0,81 kg/m	
	1577	...	0,57 kg/m	
	1862	...	0,252 kg/m	
	2082	...	0,177 kg/m	
	1272	...	0,322 kg/m	
	1573	...	0,108 kg/m	
	1700	...	0,140 kg/m	
	1810	...	0,155 kg/m	
	1268	...	0,101 kg/m	















★ Yandaki profil birim ağırlıkları, bilgisayarda hesaplanmış teorik ağırlıklardır.

PROFİL KESİTİ	PROFİL KODU	PROFİL ADI	AĞIRLIK	ATALET MOMENTLERİ		SAYFA NO
				J_x (cm ⁴)	J_y (cm ⁴)	
	2051	...	0,216 kg/m	
	1784	...	0,130 kg/m	
	1387	...	0,137 kg/m	
	1019	...	0,162 kg/m	
	1568	...	0,85 kg/m	
	1861	...	0,250 kg/m	
	1652	...	0,168 kg/m	
	1390	...	0,424 kg/m	
	1389	...	0,225 kg/m	
	2083	...	0,232 kg/m	
	1691	...	0,272 kg/m	
	2357	...	0,341 kg/m	
	2358	...	0,163 kg/m	
	2241	...	0,226 kg/m	

★ Yandaki profil birim ağırlıkları, bilgisayarda hesaplanmış teorik ağırlıklardır.

PROFİL KESİTİ	PROFİL KODU	PROFİL ADI	AĞIRLIK	ATALET MOMENTLERİ		SAYFA NO
				J_x (cm ⁴)	J_y (cm ⁴)	
	2353	...	0,98 kg/m	
	2354	...	0,111 kg/m	
	2828	...	0,146 kg/m	
	2781	...	0,282 kg/m	
	2352	...	0,103 kg/m	
	2752	...	0,148 kg/m	
	1142	...	0,128 kg/m	
	1683	...	0,118 kg/m	
	1257	...	0,123 kg/m	
	1730	...	0,113 kg/m	
	1074	...	0,83 kg/m	
	1823	...	0,121 kg/m	
	1552	...	0,103 kg/m	
	1397	...	0,118 kg/m	

★ Yandaki profil birim ağırlıkları, bilgisayarda hesaplanmış teorik ağırlıklardır.

PROFİL KESİTİ	PROFİL KODU	PROFİL ADI	AĞIRLIK	ATALET MOMENTLERİ		SAYFA NO
				J_x (cm ⁴)	J_y (cm ⁴)	
	1757	...	0,101 kg/m	
	1917	...	0,144 kg/m	
	1651	...	0,156 kg/m	
	1660	...	0,155 kg/m	
	1602	...	0,158 kg/m	
	1570	...	0,138 kg/m	
	1576	...	0,134 kg/m	
	1777	...	0,116 kg/m	
	1793	...	0,104 kg/m	
	1783	...	0,108 kg/m	
	1782	...	0,101 kg/m	
	1616	...	0,142 kg/m	
	1274	...	0,138 kg/m	
	1032	...	0,162 kg/m	

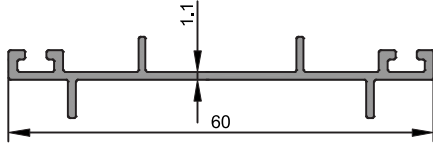

1755
0,290 kg/m

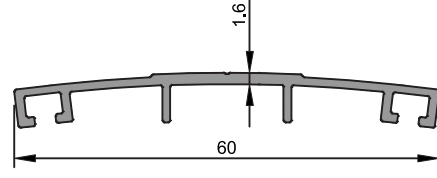

1756
0,319 kg/m

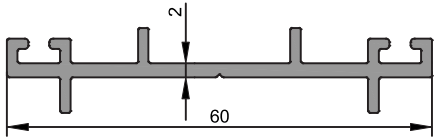

1121
0,486 kg/m

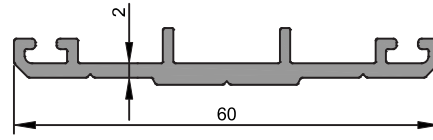

1222
0,490 kg/m

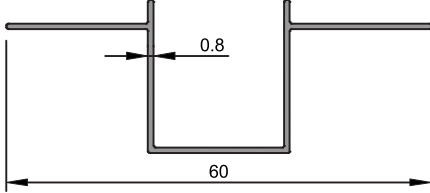

1831
0,220 kg/m

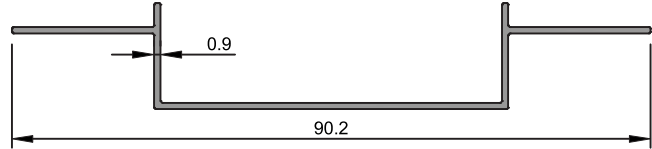

1834
0,288 kg/m

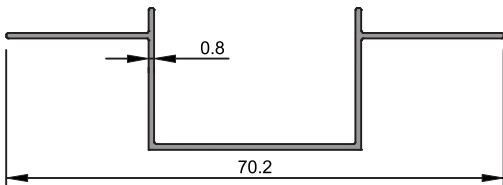

1832
0,235 kg/m

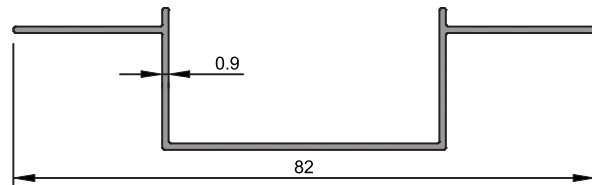

1833
0,293 kg/m

★ Yandaki profil birim ağırlıkları, bilgisayarda hesaplanmış teorik ağırlıklardır.

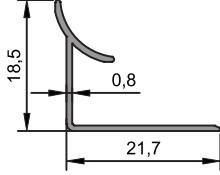

1574
0,101 kg/m

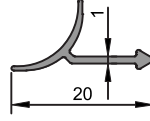

1681
0,75 kg/m

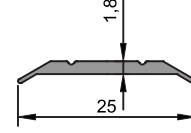

1773
0,97 kg/m

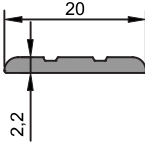

1781
0,110 kg/m

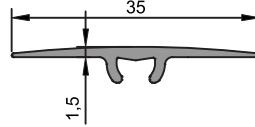

1780
0,144 kg/m

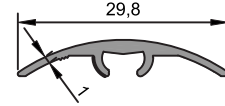

1775
0,141 kg/m

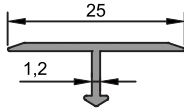

1575
0,105 kg/m

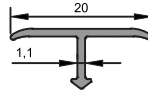

1571
0,81 kg/m

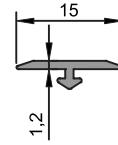

1577
0,57 kg/m

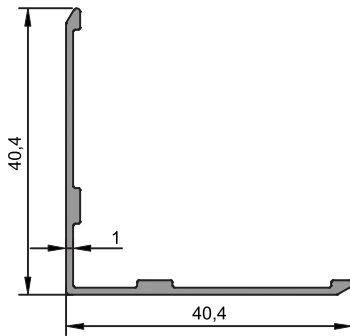

1862
0,252 kg/m

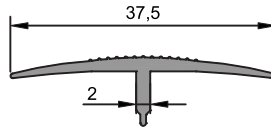

2082
0,177 kg/m

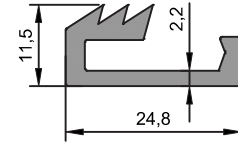

1272
0,322 kg/m

★ Yandaki profil birim ağırlıkları, bilgisayarda hesaplanmış teorik ağırlıklardır.

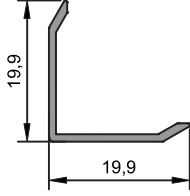

1573
0,108 kg/m

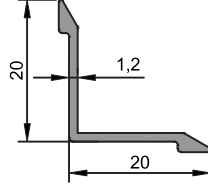

1700
0,140 kg/m

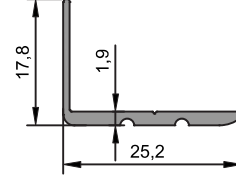

1810
0,155 kg/m

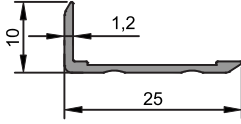

1268
0,101 kg/m

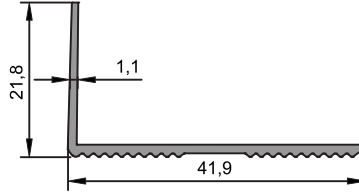

2051
0,216 kg/m

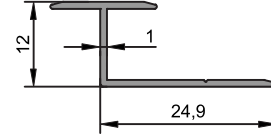

1784
0,130 kg/m

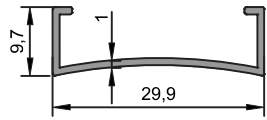

1387
0,137 kg/m

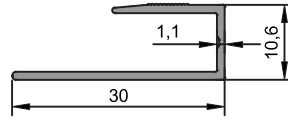

1019
0,162 kg/m

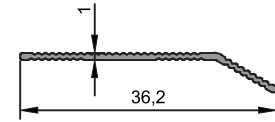

1568
0,85 kg/m

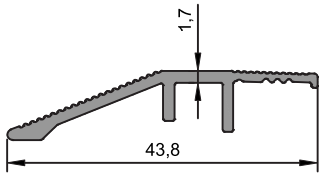

1861
0,250 kg/m

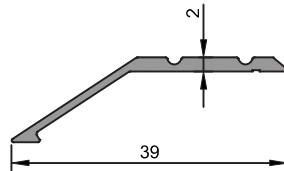

1652
0,168 kg/m

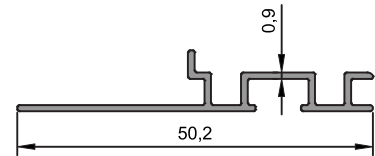

1390
0,424 kg/m

★ Yandaki profil birim ağırlıkları, bilgisayarda hesaplanmış teorik ağırlıklardır.

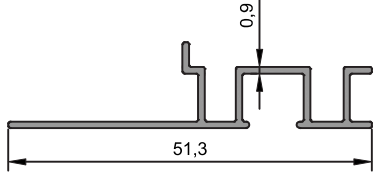

1389

0,225 kg/m

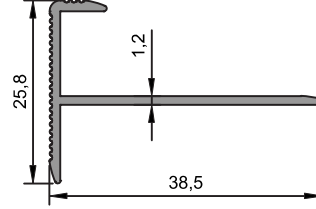

2083

0,232 kg/m

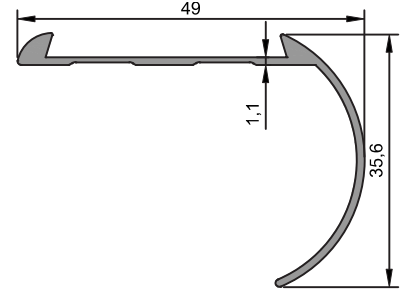

1691

0,272 kg/m

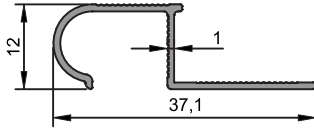

2357

0,341 kg/m

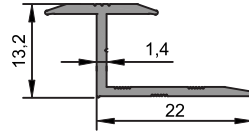

2358

0,163 kg/m

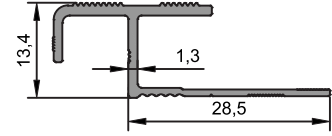

2241

0,226 kg/m

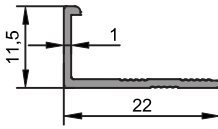

2353

0,98 kg/m

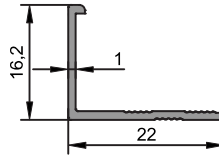

2354

0,111 kg/m

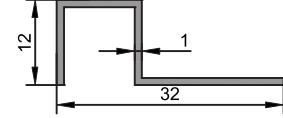

2828

0,146 kg/m

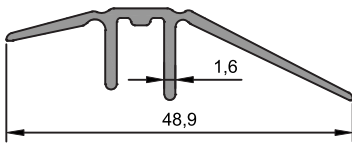

2781

0,282 kg/m

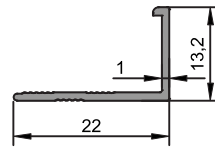

2352

0,103 kg/m

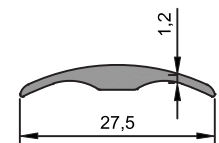

2752

0,148 kg/m

★ Yandaki profil birim ağırlıkları, bilgisayarda hesaplanmış teorik ağırlıklardır.

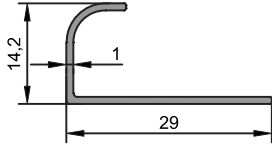

1142

0,128 kg/m

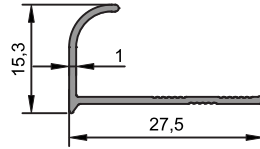

1683

0,118 kg/m

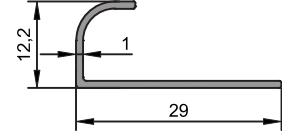

1257

0,123 kg/m

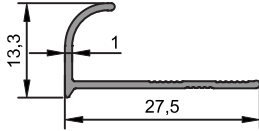

1730

0,113 kg/m

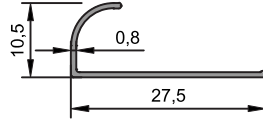

1074

0,83 kg/m

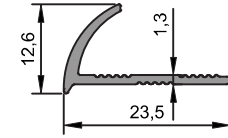

1823

0,121 kg/m

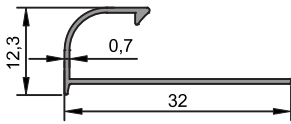

1552

0,103 kg/m

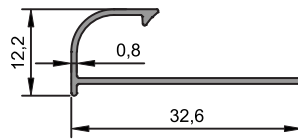

1397

0,118 kg/m

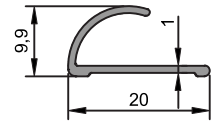

1757

0,101 kg/m

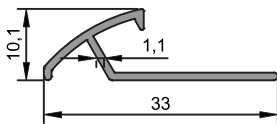

1617

0,144 kg/m

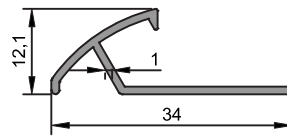

1651

0,156 kg/m

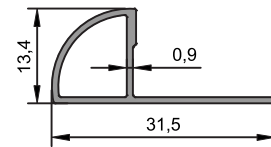

1660

0,155 kg/m

★ Yandaki profil birim ağırlıkları, bilgisayarda hesaplanmış teorik ağırlıklardır.

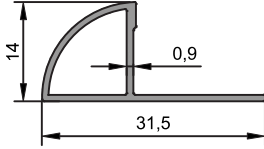

1602

0,158 kg/m

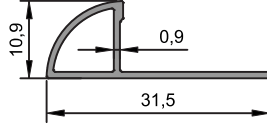

1570

0,138 kg/m

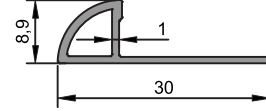

1576

0,134 kg/m

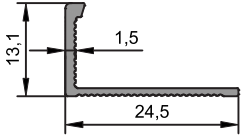

1777

0,116 kg/m

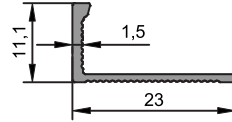

1793

0,104 kg/m

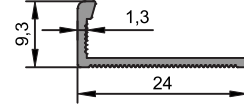

1783

0,108 kg/m

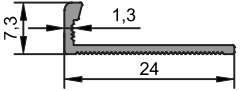

1782

0,101 kg/m

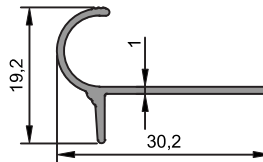

1616

0,142 kg/m

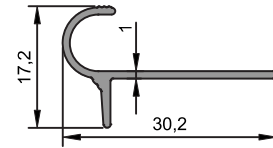

1274

0,138 kg/m

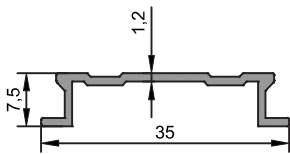

1032

0,162 kg/m

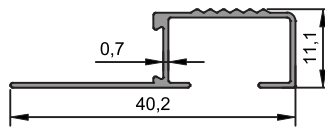

1380

0,146 kg/m

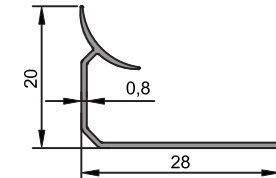

1229

0,106 kg/m

★ Yandaki profil birim ağırlıkları, bilgisayarda hesaplanmış teorik ağırlıklardır.

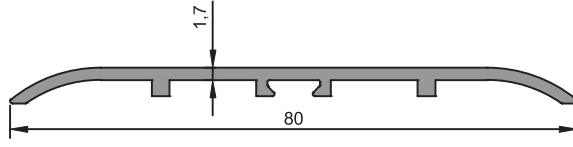

1669
0,424 kg/m

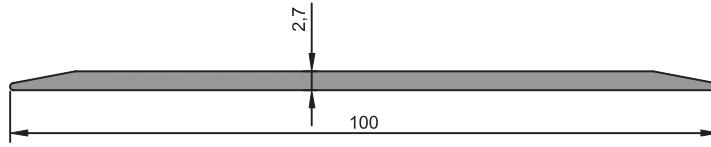

1320
0,686 kg/m

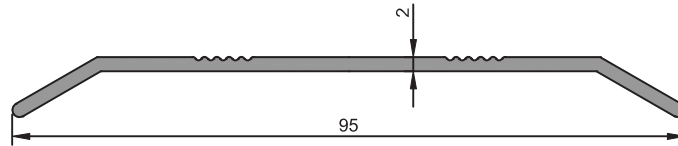

1792
0,519 kg/m

★ Yandaki profil birim ağırlıkları, bilgisayarda hesaplanmış teorik ağırlıklardır.