



HİLAL
Alüminyum

PROFİL KATALOĐU









ARA BÖLME PROFİLLERİ

PARTITION PROFILES

★ Profil Ağırlıkları Teorik Olup Teslim Anındaki Ağırlık Geçerlidir

★ *Weight of profiles are theoretical, net weight will valid at the time of delivery.*

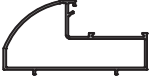
★ Yandaki profil birim ağırlıkları, bilgisayarda hesaplanmış teorik ağırlıklardır.

PROFİL KESİTİ	PROFİL KODU	PROFİL ADI	AĞIRLIK	ATALET MOMENTLERİ		SAYFA NO
				J_x (cm ⁴)	J_y (cm ⁴)	
	2924	Köşe Profili	1,949 kg/m	
	2923	Kasa Profili	1,208 kg/m	
	2939	Köşe Profili	1,691 kg/m	
	2922	Adaptör	0,810 kg/m	
	2921	Kapak Profili	0,196 kg/m	
	2944	Bağlantı Profili	0,670 kg/m	
	2925	Kapı Kasa Profili	1,297 kg/m	
	2920	Bağlantı Profili	0,503 kg/m	

2924
Köşe Profili
1,949 kg/m

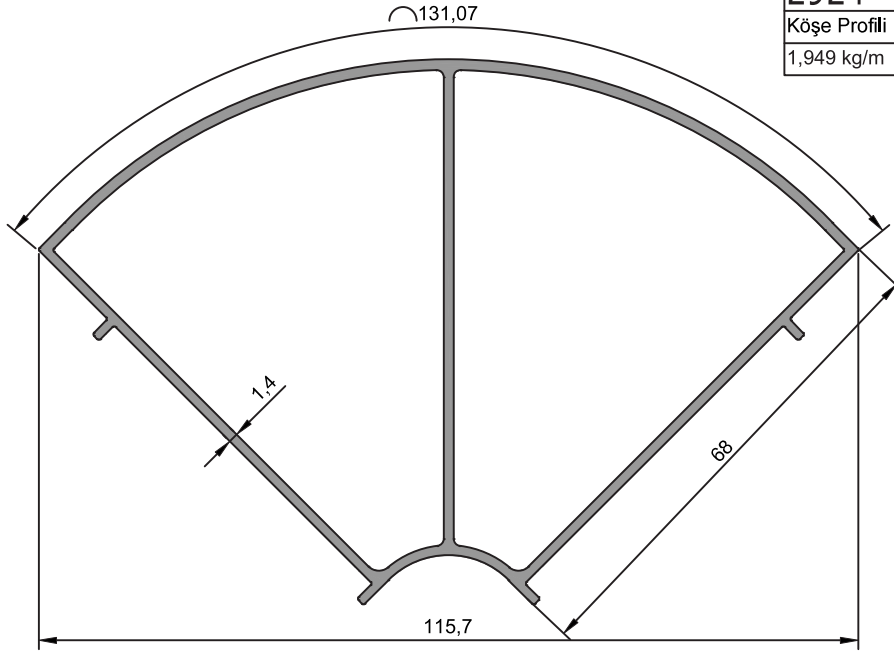

2923
Kasa Profili
1,208 kg/m

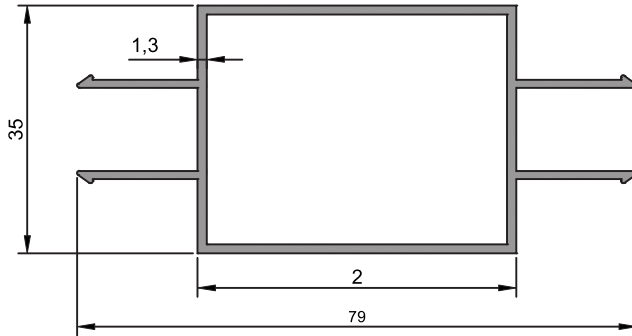

★ Yandaki profil birim ağırlıkları, bilgisayarda hesaplanmış teorik ağırlıklardır.

★ Yandaki profil birim ağırlıkları, bilgisayarda hesaplanmış teorik ağırlıklardır.

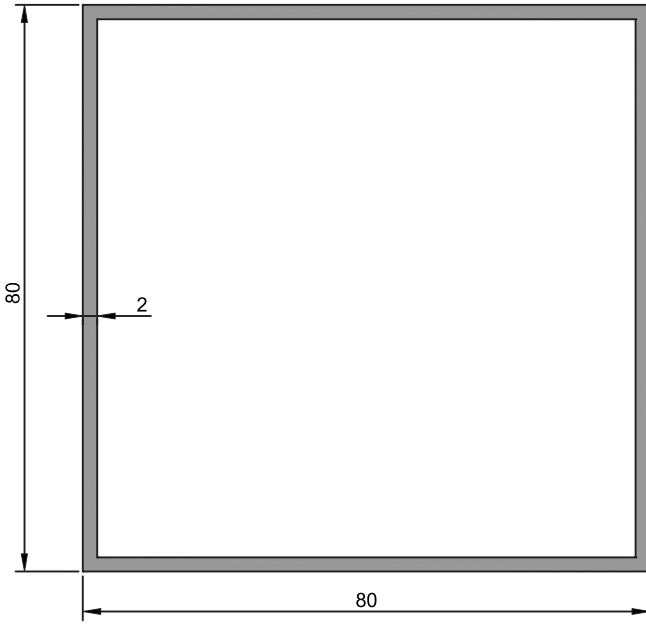

2939
Köşe Profili
1,691 kg/m

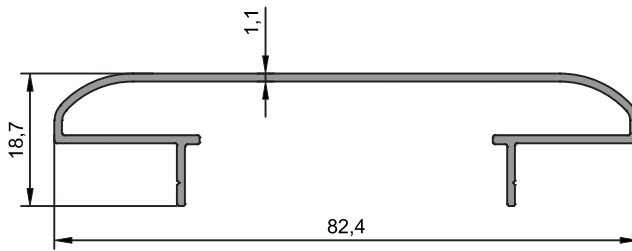

2922
Adaptör
0,810 kg/m

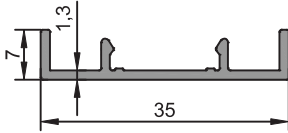

2921
Kapak Profili
0,196 kg/m

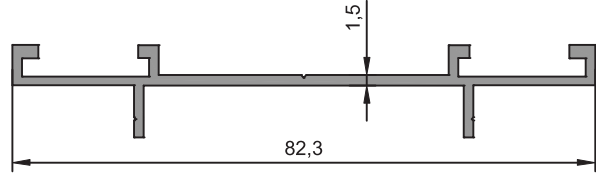

2944
Bağlantı Profili
0,670 kg/m

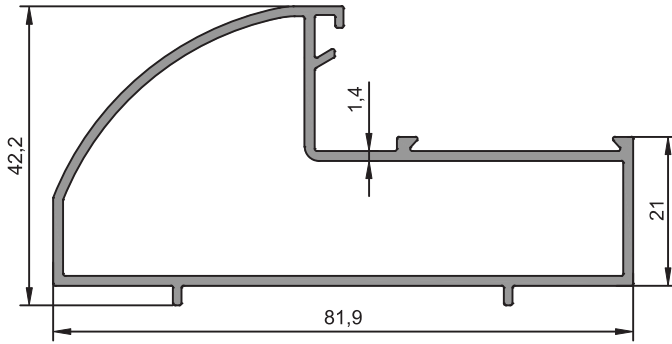

2925
Kapı Kasa Profili
1,297 kg/m

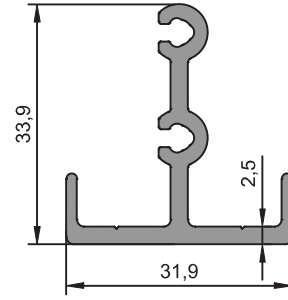

2920
Bağlantı Profili
0,503 kg/m

★ Yandaki profil birim ağırlıkları, bilgisayarda hesaplanmış teorik ağırlıklardır.

★ Yandaki profil birim ağırlıkları, bilgisayarda hesaplanmış teorik ağırlıklardır.

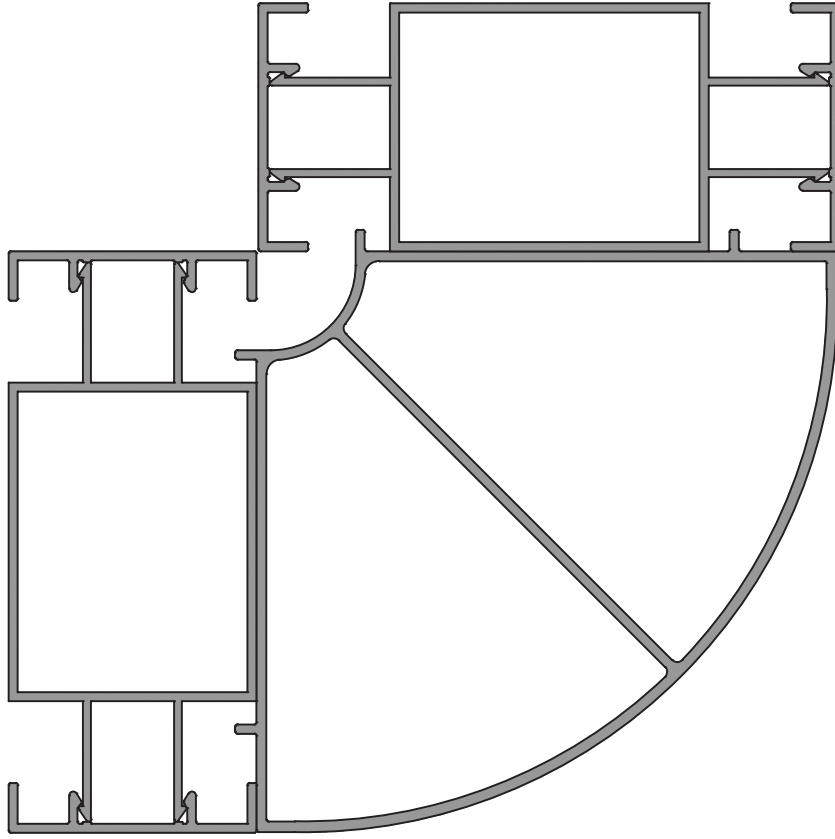

★ Yandaki profil birim ağırlıkları, bilgisayarda hesaplanmış teorik ağırlıklardır.

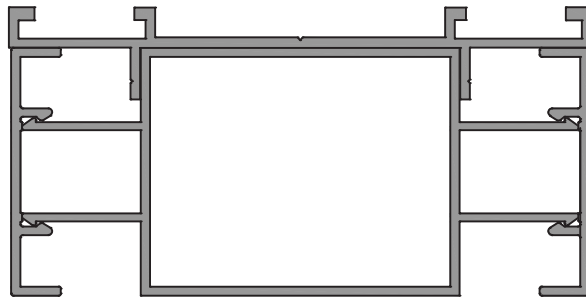
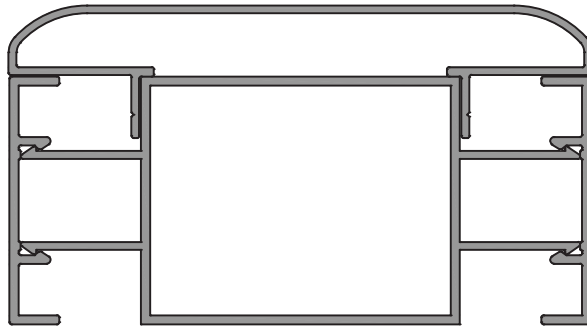

★ Yandaki profil birim ağırlıkları, bilgisayarda hesaplanmış teorik ağırlıklardır.

