



**HİLAL**  
Alüminyum

**PROFİL KATALOĐU**















**MOBİLYA PROFİLLERİ**

*FURNITURE PROFILES*















★ Profil Ağırlıkları Teorik Olup Teslim Anındaki Ağırlık Geçerlidir

★ *Weight of profiles are theoretical, net weight will valid at the time of delivery.*



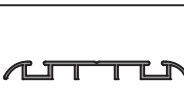

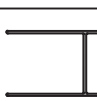





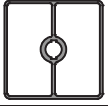
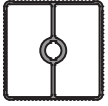

★ Yandaki profil birim ağırlıkları, bilgisayarda hesaplanmış teorik ağırlıklardır.

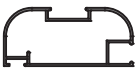





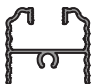





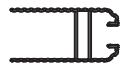

PROFİL KESİTİ	PROFİL KODU	PROFİL ADI	AĞIRLIK	ATALET MOMENTLERİ		SAYFA NO
				$J_x$ (cm <sup>4</sup> )	$J_y$ (cm <sup>4</sup> )	
	1960	...	0,261 kg/m	...	...	
	1961	...	0,396 kg/m	...	...	
	1962	...	0,242 kg/m	...	...	
	1116	...	0,244 kg/m	...	...	
	1631	...	0,589 kg/m	...	...	
	1996	...	0,265 kg/m	...	...	
	2007	...	0,262 kg/m	...	...	
	1975	...	0,487 kg/m	...	...	
	2024	...	0,474 kg/m	...	...	
	1664	...	0,260 kg/m	...	...	
	1596	...	0,347 kg/m	...	...	
	1641	...	0,331 kg/m	...	...	
	1965	...	0,362 kg/m	...	...	
	1598	...	0,305 kg/m	...	...	

★ Yandaki profil birim ağırlıkları, bilgisayarda hesaplanmış teorik ağırlıklardır.

PROFİL KESİTİ	PROFİL KODU	PROFİL ADI	AĞIRLIK	ATALET MOMENTLERİ		SAYFA NO
				$J_x$ (cm <sup>4</sup> )	$J_y$ (cm <sup>4</sup> )	
	1956	...	0,356 kg/m	...	...	
	2045	...	0,221 kg/m	...	...	
	2046	...	0,276 kg/m	...	...	
	2050	...	0,358 kg/m	...	...	
	2048	...	0,442 kg/m	...	...	
	1665	...	0,495 kg/m	...	...	
	1813	...	0,466 kg/m	...	...	
	1581	...	0,392 kg/m	...	...	
	1148	...	0,389 kg/m	...	...	
	1180	...	0,283 kg/m	...	...	
	2049	...	0,222 kg/m	...	...	
	2045	...	0,519 kg/m	...	...	
	2047	...	0,385 kg/m	...	...	
	1249	...	0,733 kg/m	...	...	















★ Yandaki profil birim ağırlıkları, bilgisayarda hesaplanmış teorik ağırlıklardır.

PROFİL KESİTİ	PROFİL KODU	PROFİL ADI	AĞIRLIK	ATALET MOMENTLERİ		SAYFA NO
				$J_x$ (cm <sup>4</sup> )	$J_y$ (cm <sup>4</sup> )	
	1245	...	0,695 kg/m	...	...	
	1179	...	0,661 kg/m	...	...	
	1242	...	0,571 kg/m	...	...	
	1309	...	0,326 kg/m	...	...	
	1385	...	0,326 kg/m	...	...	
	1498	...	0,322 kg/m	...	...	
	1181	...	0,391 kg/m	...	...	
	1182	...	0,485 kg/m	...	...	
	1186	...	0,64 kg/m	...	...	
	1467	...	0,495 kg/m	...	...	
	1698	...	0,459 kg/m	...	...	
	1548	...	0,256 kg/m	...	...	
	1549	...	0,320 kg/m	...	...	
	1669	...	0,292 kg/m	...	...	















PROFİL KESİTİ	PROFİL KODU	PROFİL ADI	AĞIRLIK	ATALET MOMENTLERİ		SAYFA NO
				$J_x$ (cm <sup>4</sup> )	$J_y$ (cm <sup>4</sup> )	
	1670	...	0,340 kg/m	...	...	
	1276	...	0,346 kg/m	...	...	
	1278	...	0,497 kg/m	...	...	
	1668	...	0,528 kg/m	...	...	
	1550	...	0,425 kg/m	...	...	
	1551	...	0,508 kg/m	...	...	
	1620	...	0,209 kg/m	...	...	
	1663	...	0,60 kg/m	...	...	
	1666	...	0,434 kg/m	...	...	
	1546	...	0,445 kg/m	...	...	
	1547	...	0,236 kg/m	...	...	
	1279	...	0,603 kg/m	...	...	
	1277	...	0,228 kg/m	...	...	
	1671	...	0,376 kg/m	...	...	

★ Yandaki profil birim ağırlıkları, bilgisayarda hesaplanmış teorik ağırlıklardır.















★ Yandaki profil birim ağırlıkları, bilgisayarda hesaplanmış teorik ağırlıklardır.

PROFİL KESİTİ	PROFİL KODU	PROFİL ADI	AĞIRLIK	ATALET MOMENTLERİ		SAYFA NO
				$J_x$ (cm <sup>4</sup> )	$J_y$ (cm <sup>4</sup> )	
	1392	...	0,263 kg/m	...	...	
	1393	...	0,276 kg/m	...	...	
	1360	...	0,146 kg/m	...	...	
	2035	...	0,379 kg/m	...	...	
	1661	...	0,239 kg/m	...	...	
	1662	...	0,167 kg/m	...	...	
	2033	...	0,156 kg/m	...	...	
	1816	...	0,135 kg/m	...	...	
	1963	...	0,147 kg/m	...	...	
	1964	...	0,224 kg/m	...	...	
	2043	...	0,299 kg/m	...	...	
	1141	...	0,208 kg/m	...	...	
	1815	...	0,167 kg/m	...	...	
	2031	...	0,309 kg/m	...	...	











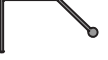

★ Yandaki profil birim ağırlıkları, bilgisayarda hesaplanmış teorik ağırlıklardır.

PROFİL KESİTİ	PROFİL KODU	PROFİL ADI	AĞIRLIK	ATALET MOMENTLERİ		SAYFA NO
				$J_x$ (cm <sup>4</sup> )	$J_y$ (cm <sup>4</sup> )	
	1824	...	0,219 kg/m	...	...	
	1968	...	0,101 kg/m	...	...	
	1974	...	0,79 kg/m	...	...	
	2085	...	0,92 kg/m	...	...	
	1766	...	0,69 kg/m	...	...	
	1049	...	0,63 kg/m	...	...	
	1376	...	0,234 kg/m	...	...	
	1377	...	0,218 kg/m	...	...	
	1957	...	0,197 kg/m	...	...	
	1449	...	0,190 kg/m	...	...	
	1291	...	0,311 kg/m	...	...	
	1814	...	0356 kg/m	...	...	
	2034	...	0,163 kg/m	...	...	
	1966	...	0,215 kg/m	...	...	

★ Yandaki profil birim ağırlıkları, bilgisayarda hesaplanmış teorik ağırlıklardır.











PROFİL KESİTİ	PROFİL KODU	PROFİL ADI	AĞIRLIK	ATALET MOMENTLERİ		SAYFA NO
				$J_x$ (cm <sup>4</sup> )	$J_y$ (cm <sup>4</sup> )	
	1967	...	0,192 kg/m	...	...	
	1667	...	0,312 kg/m	...	...	
	1715	...	0,106 kg/m	...	...	
	1954	...	0,288 kg/m	...	...	
	1689	...	0,222 kg/m	...	...	
	1716	...	0,170 kg/m	...	...	
	1859	...	0,282 kg/m	...	...	
	1608	...	0,538 kg/m	...	...	
	1684	...	0,822 kg/m	...	...	
	2032	...	0,530 kg/m	...	...	
	1741	...	0,294 kg/m	...	...	
	1742	...	0,360 kg/m	...	...	
	1530	...	0,549 kg/m	...	...	
	1638	...	0,676 kg/m	...	...	



PROFİL KESİTİ	PROFİL KODU	PROFİL ADI	AĞIRLIK	ATALET MOMENTLERİ		SAYFA NO
				$J_x$ (cm <sup>4</sup> )	$J_y$ (cm <sup>4</sup> )	
	1736	...	0,488 kg/m	...	...	
	1688	...	0,187 kg/m	...	...	
	1708	...	0,119 kg/m	...	...	
	1710	...	0,112 kg/m	...	...	
	1814	...	0,491 kg/m	...	...	
	1712	...	0,141 kg/m	...	...	
	1709	...	0,68 kg/m	...	...	
	1711	...	0,71 kg/m	...	...	
	1714	...	0,346 kg/m	...	...	
	1460	...	0,279 kg/m	...	...	
	1428	...	0,249 kg/m	...	...	
	1687	...	0,479 kg/m	...	...	
	1293	...	0,683 kg/m	...	...	
	1597	...	0,396 kg/m	...	...	

★ Yandaki profil birim ağırlıkları, bilgisayarda hesaplanmış teorik ağırlıklardır.

★ Yandaki profil birim ağırlıkları, bilgisayarda hesaplanmış teorik ağırlıklardır.

PROFİL KESİTİ	PROFİL KODU	PROFİL ADI	AĞIRLIK	ATALET MOMENTLERİ		SAYFA NO
				$J_x$ (cm <sup>4</sup> )	$J_y$ (cm <sup>4</sup> )	
	1743	...	0,506 kg/m	...	...	
	1713	...	0,259 kg/m	...	...	
	1898	...	0,291 kg/m	...	...	
	1899	...	0,463 kg/m	...	...	
	1900	...	0,434 kg/m	...	...	
	1901	...	0,394 kg/m	...	...	
	1306	...	0,351 kg/m	...	...	
	1307	...	0,310 kg/m	...	...	
	1727	...	0,312 kg/m	...	...	
	1427	...	0,430 kg/m	...	...	

★ Yandaki profil birim ağırlıkları, bilgisayarda hesaplanmış teorik ağırlıklardır.

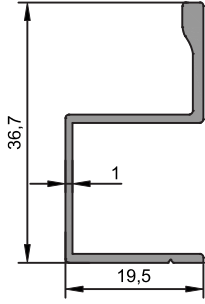

**1960**

0,261 kg/m

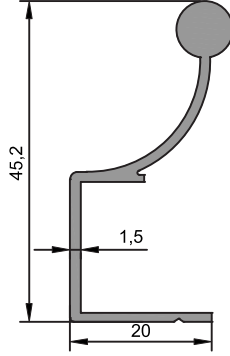

**1961**

0,396 kg/m

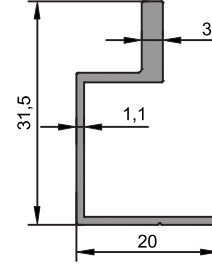

**1962**

0,242 kg/m

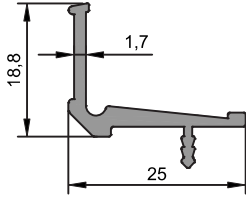

**1116**

0,244 kg/m

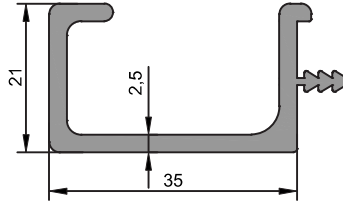

**1631**

0,589 kg/m

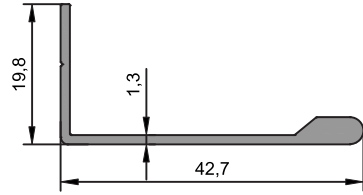

**1996**

0,265 kg/m

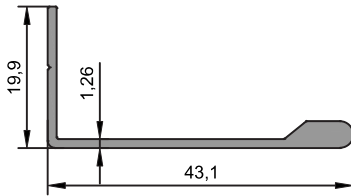

**2007**

0,262 kg/m

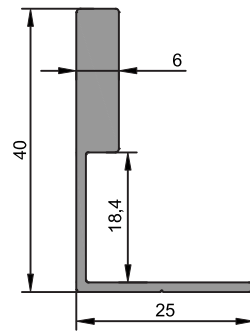

**1975**

0,487 kg/m

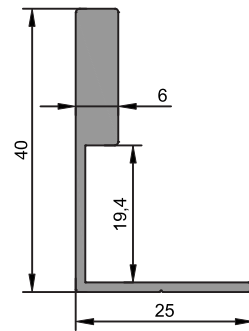

**2024**

0,474 kg/m

★ Yandaki profil birim ağırlıkları, bilgisayarda hesaplanmış teorik ağırlıklardır.

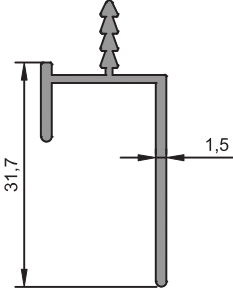

**1664**

0,260 kg/m

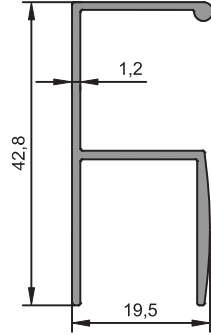

**1596**

0,347 kg/m

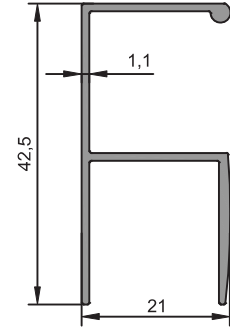

**1641**

0,331 kg/m

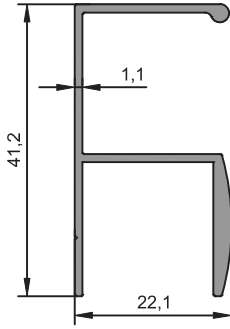

**1965**

0,362 kg/m

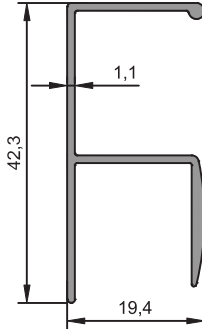

**1598**

0,305 kg/m

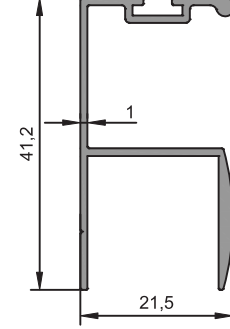

**1956**

0,336 kg/m

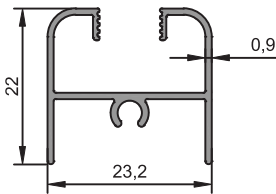

**2045**

0,221 kg/m

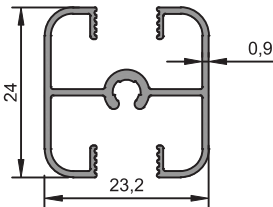

**2046**

0,276 kg/m

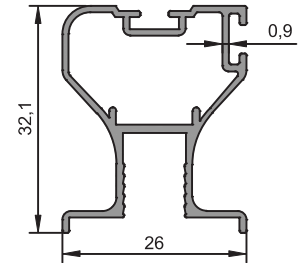

**2050**

0,358 kg/m

★ Yandaki profil birim ağırlıkları, bilgisayarda hesaplanmış teorik ağırlıklardır.

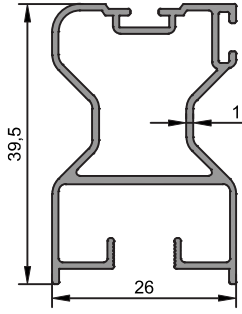

**2048**

0,442 kg/m

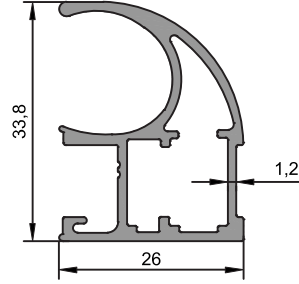

**1665**

0,495 kg/m

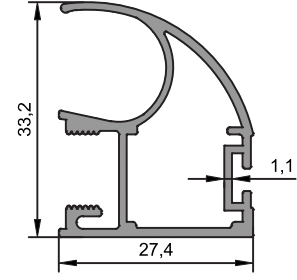

**1813**

0,466 kg/m

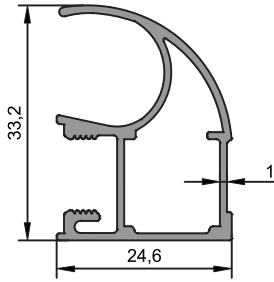

**1581**

0,392 kg/m

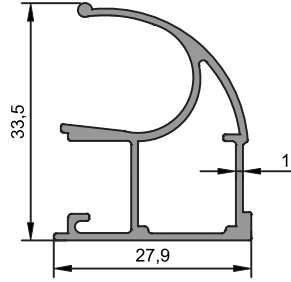

**1148**

0,389 kg/m

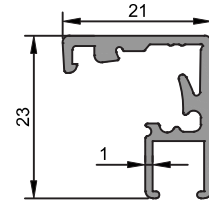

**1180**

0,283 kg/m

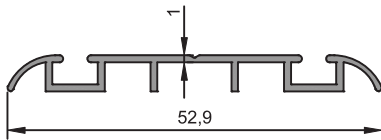

**2049**

0,222 kg/m

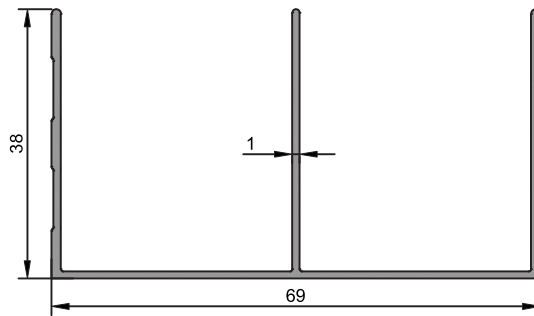

**2044**

0,519 kg/m

★ Yandaki profil birim ağırlıkları, bilgisayarda hesaplanmış teorik ağırlıklardır.

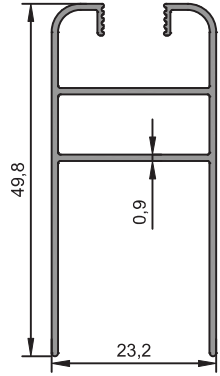

**2047**  
0,385 kg/m

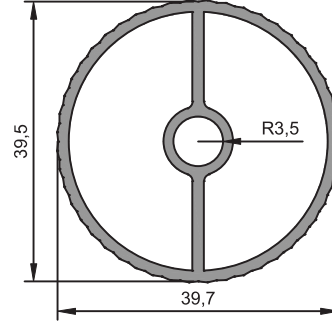

**1249**  
0,733 kg/m

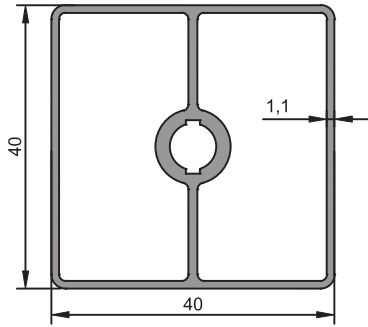

**1245**  
0,695 kg/m

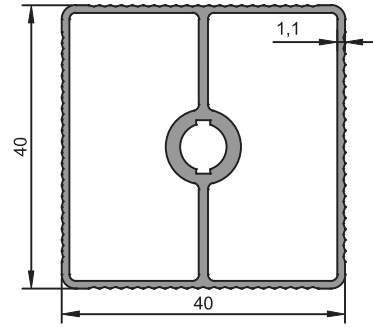

**1179**  
0,661 kg/m

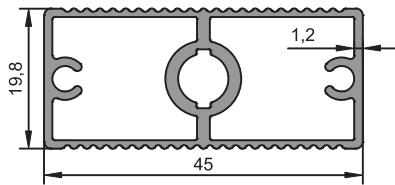

**1242**  
0,571 kg/m

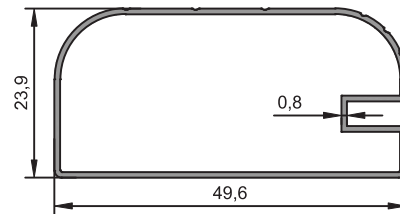

**1309**  
0,326 kg/m

★ Yandaki profil birim ağırlıkları, bilgisayarda hesaplanmış teorik ağırlıklardır.



**1385**

0,326 kg/m

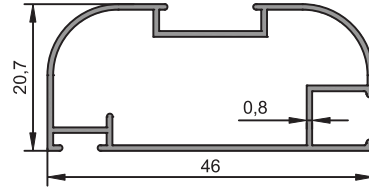

**1498**

0,322 kg/m

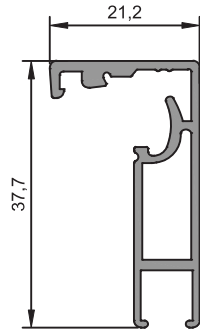

**1181**

0,391 kg/m

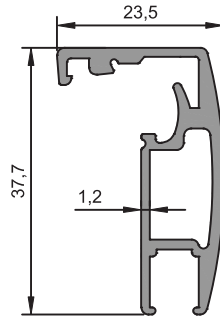

**1182**

0,485 kg/m

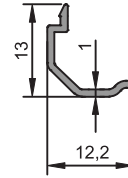

**1186**

0,64 kg/m

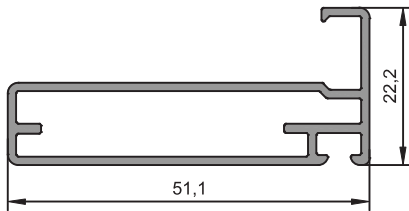

**1467**

0,495 kg/m

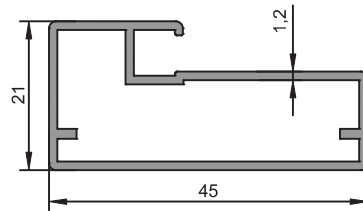

**1698**

0,459 kg/m

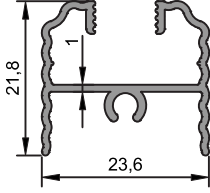

**1548**

0,256 kg/m

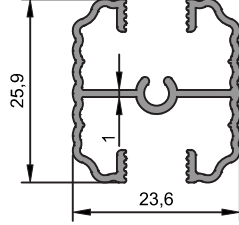

**1549**

0,320 kg/m

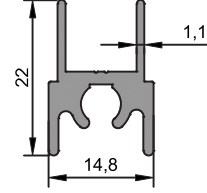

**1669**

0,292 kg/m

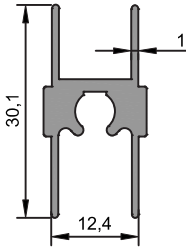

**1670**

0,340 kg/m

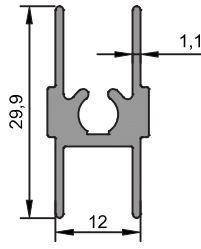

**1276**

0,346 kg/m

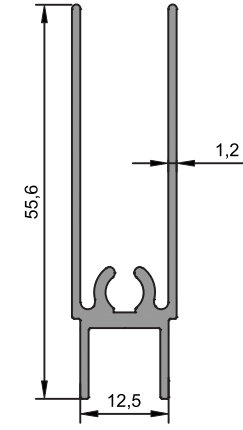

**1278**

0,497 kg/m

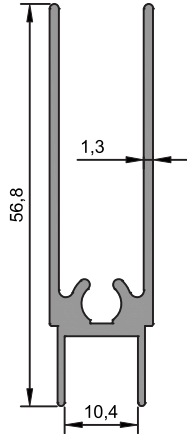

**1668**

0,528 kg/m

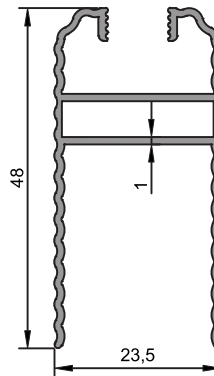

**1550**

0,425 kg/m

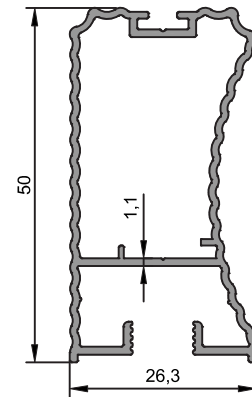

**1551**

0,508 kg/m

★ Yandaki profil birim ağırlıkları, bilgisayarda hesaplanmış teorik ağırlıklardır.



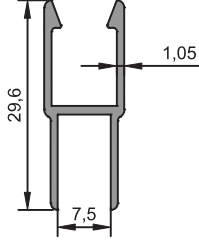

**1620**  
0,209 kg/m

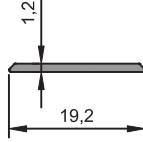

**1663**  
0,60 kg/m

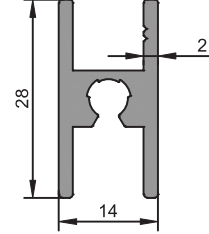

**1666**  
0,434 kg/m

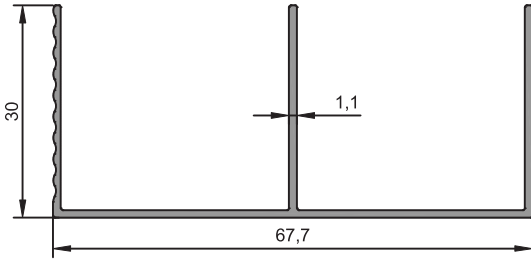

**1546**  
0,445 kg/m

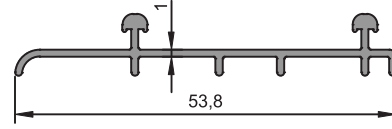

**1547**  
0,236 kg/m

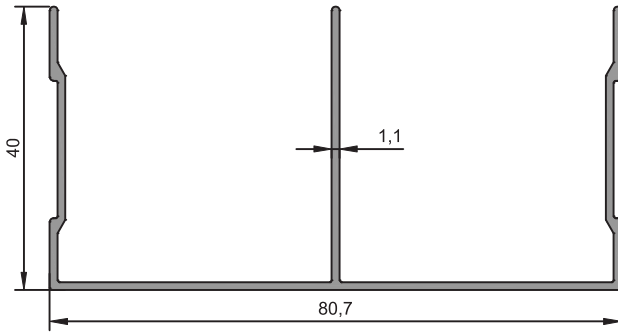

**1279**  
0,603 kg/m

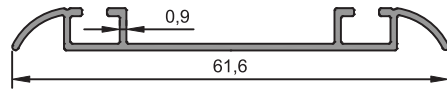

**1277**  
0,228 kg/m

★ Yandaki profil birim ağırlıkları, bilgisayarda hesaplanmış teorik ağırlıklardır.

★ Yandaki profil birim ağırlıkları, bilgisayarda hesaplanmış teorik ağırlıklardır.

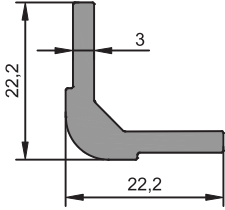

**1671**

0,376 kg/m

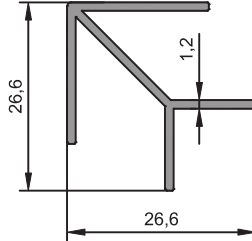

**1392**

0,263 kg/m

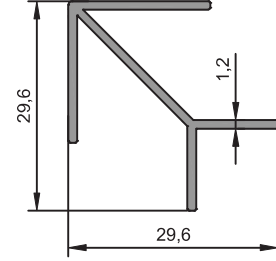

**1393**

0,276 kg/m

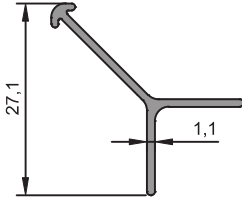

**1360**

0,146 kg/m

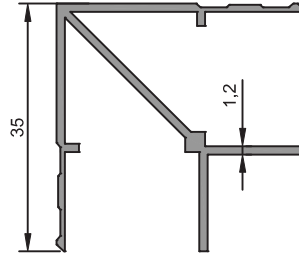

**2035**

0,379 kg/m

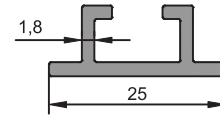

**1661**

0,239 kg/m

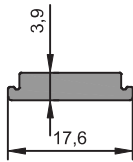

**1662**

0,167 kg/m

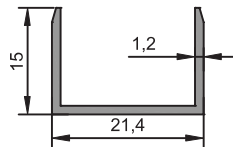

**2033**

0,156 kg/m

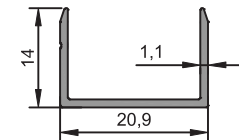

**1816**

0,135 kg/m

★ Yandaki profil birim ağırlıkları, bilgisayarda hesaplanmış teorik ağırlıklardır.

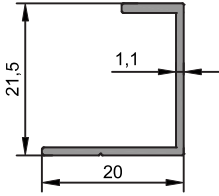

**1963**  
0,147 kg/m

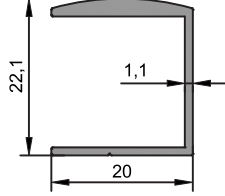

**1964**  
0,224 kg/m

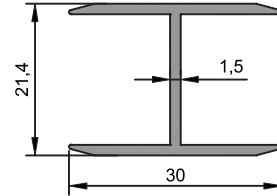

**2043**  
0,299 kg/m

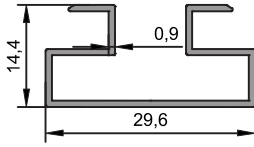

**1141**  
0,208 kg/m

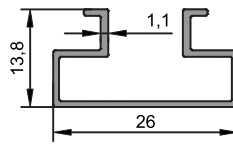

**1815**  
0,167 kg/m

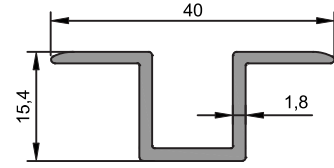

**2031**  
0,309 kg/m

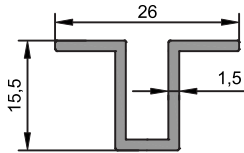

**1824**  
0,219 kg/m

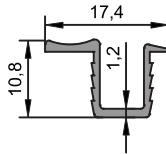

**1968**  
0,101 kg/m

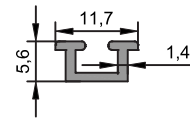

**1974**  
0,79 kg/m

★ Yandaki profil birim ağırlıkları, bilgisayarda hesaplanmış teorik ağırlıklardır.

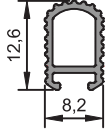

**2085**  
0,92 kg/m

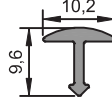

**1766**  
0,69 kg/m

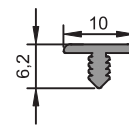

**1049**  
0,63 kg/m

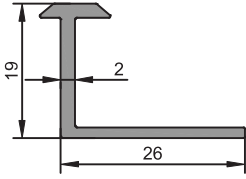

**1376**  
0,234 kg/m

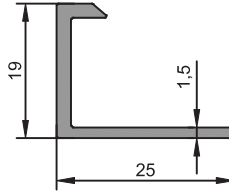

**1377**  
0,218 kg/m

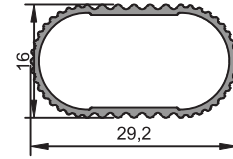

**1957**  
0,197 kg/m

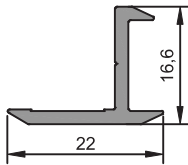

**1449**  
0,190 kg/m

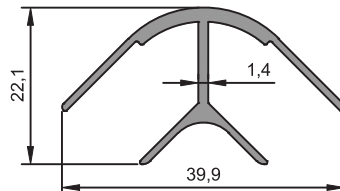

**1291**  
0,311 kg/m

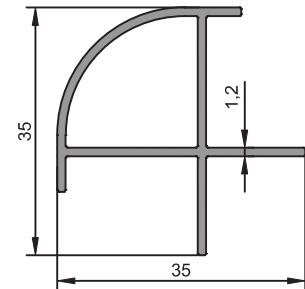

**1814**  
0,356 kg/m

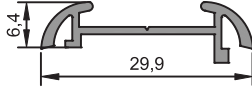

**2034**

0,163 kg/m

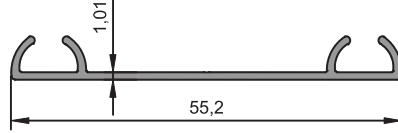

**1966**

0,215 kg/m

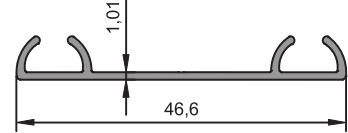

**1967**

0,192 kg/m

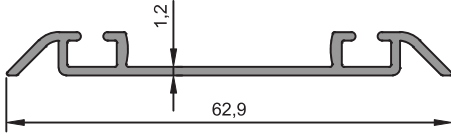

**1667**

0,312 kg/m

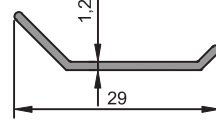

**1715**

0,106 kg/m

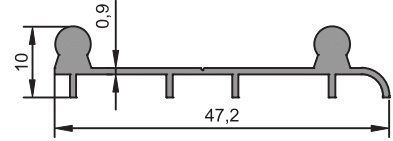

**1954**

0,288 kg/m

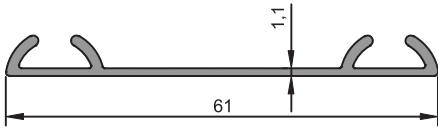

**1689**

0,222 kg/m

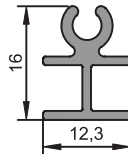

**1716**

0,170 kg/m

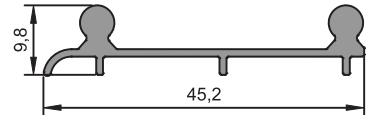

**1859**

0,282 kg/m

★ Yandaki profil birim ağırlıkları, bilgisayarda hesaplanmış teorik ağırlıklardır.

★ Yandaki profil birim ağırlıkları, bilgisayarda hesaplanmış teorik ağırlıklardır.

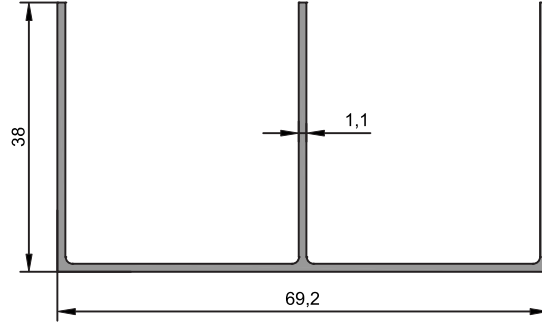

<b>1608</b>
0,538 kg/m

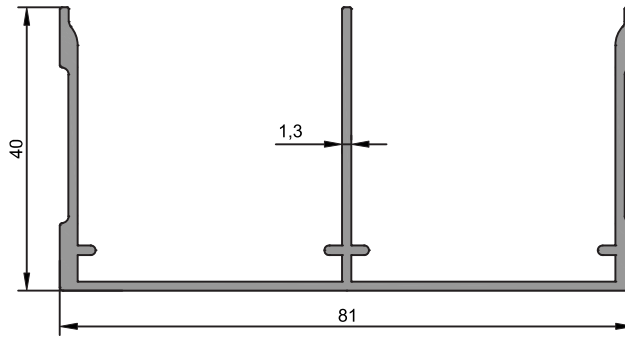

<b>1684</b>
0,822 kg/m

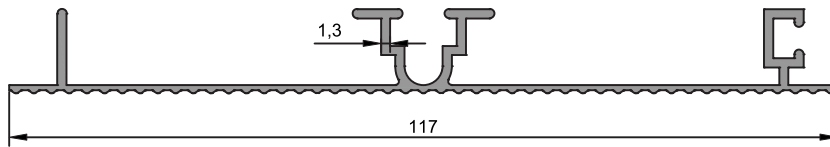

<b>2032</b>
0,530 kg/m

★ Yandaki profil birim ağırlıkları, bilgisayarda hesaplanmış teorik ağırlıklardır.

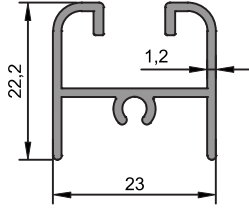

**1741**  
0,294 kg/m

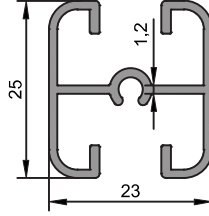

**1742**  
0,360 kg/m

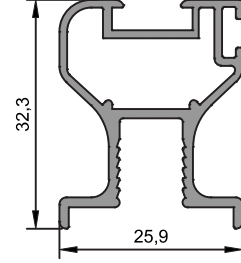

**1530**  
0,549 kg/m

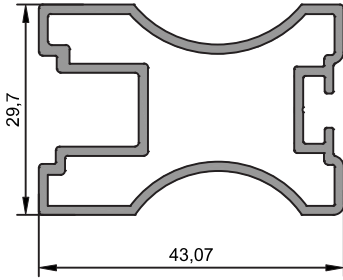

**1638**  
0,676 kg/m

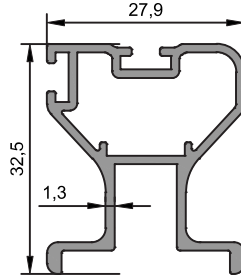

**1736**  
0,488 kg/m

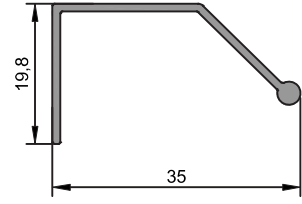

**1688**  
0,187 kg/m

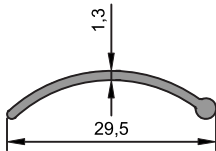

**1708**  
0,119 kg/m

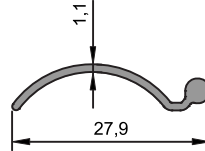

**1710**  
0,112 kg/m

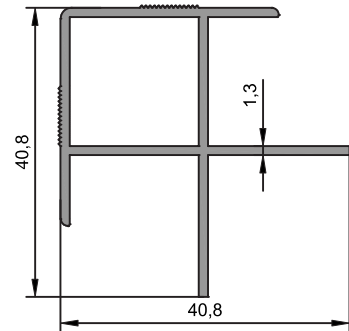

**1814**  
0,491 kg/m

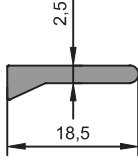

**1712**  
0,141 kg/m

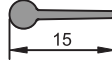

**1709**  
0,68 kg/m

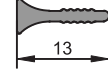

**1711**  
0,71kg/m

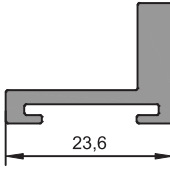

**1714**  
0,346 kg/m

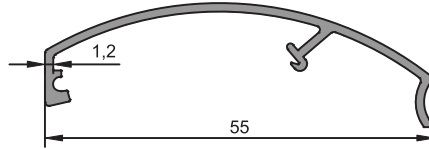

**1460**  
0,279 kg/m

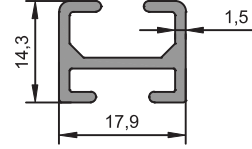

**1428**  
0,249 kg/m

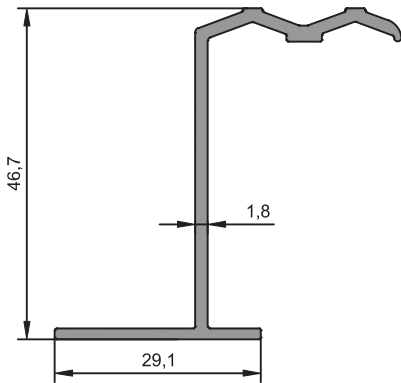

**1687**  
0,479 kg/m

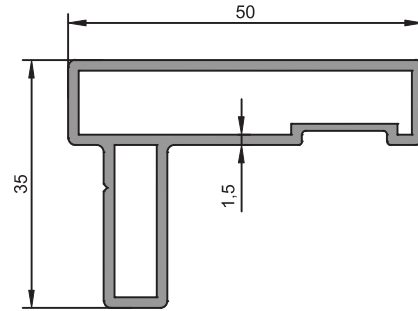

**1293**  
0,683 kg/m

★ Yandaki profil birim ağırlıkları, bilgisayarda hesaplanmış teorik ağırlıklardır.



★ Yandaki profil birim ağırlıkları, bilgisayarda hesaplanmış teorik ağırlıklardır.

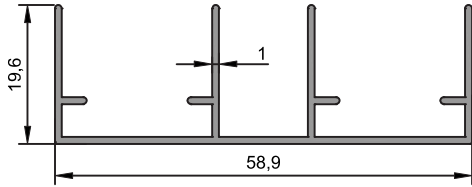

**1597**  
0,396 kg/m

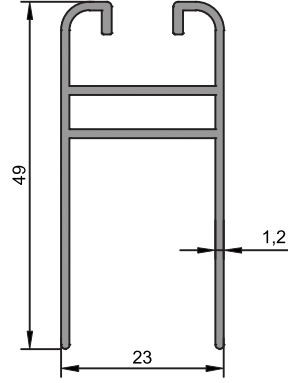

**1743**  
0,506 kg/m

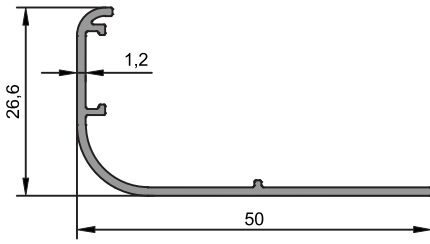

**1713**  
0,259 kg/m

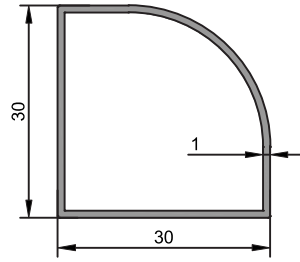

**1898**  
0,291 kg/m

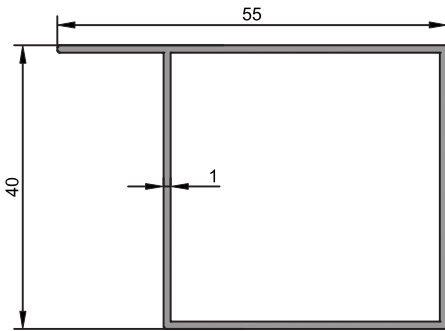

**1899**  
0,463 kg/m

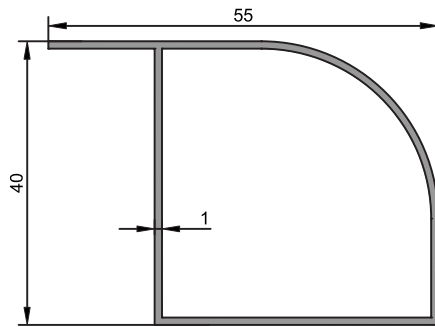

**1900**  
0,434 kg/m

★ Yandaki profil birim ağırlıkları, bilgisayarda hesaplanmış teorik ağırlıklardır.

